



X500n, X502n

User's Guide

April 2007

www.lexmark.com

Lexmark and Lexmark with diamond design are trademarks of Lexmark International, Inc., registered in the United States and/or other countries. All other trademarks are the property of their respective owners.

© 2007 Lexmark International, Inc.

All rights reserved.

740 West New Circle Road
Lexington, Kentucky 40550

Contents

- Safety information.....9**
- Learning about the printer.....10**
 - Configured models.....10
 - Understanding the control panel.....13
 - Getting the printer ready to fax.....16
 - Choosing a fax connection16
 - Using an RJ11 adapter.....16
 - Connecting directly to a telephone wall jack.....19
 - Connecting directly to a telephone wall jack in Germany20
 - Connecting to a telephone.....21
 - Connecting to an answering machine22
 - Connecting to a computer with a modem.....24
 - Setting the outgoing fax name and number.....25
 - Setting the date25
 - Setting the time.....26
- Installing options.....27**
 - Installing a 530-sheet drawer.....27
 - Securing the 530-sheet drawer to the printer.....28
 - Attaching cables.....29
- Loading paper and specialty media.....31**
 - Loading trays.....31
 - Converting the standard tray to a legal-size tray.....34
 - Setting the Paper Type.....37
 - Setting up the standard exit bin.....37
 - Linking trays.....38
- Paper and specialty media guide.....39**
 - Paper guidelines.....39
 - Paper characteristics39
 - Unacceptable paper40
 - Selecting paper.....40
 - Selecting preprinted forms and letterhead.....40
 - Using letterhead.....40
 - Using transparencies.....41
 - Using envelopes.....41
 - Using labels.....42
 - Using card stock.....43

Storing paper.....	43
Supported paper sizes, types, and weights.....	44
Supported paper sizes.....	44
Supported paper types.....	45
Supported paper weights.....	46
Paper capacities.....	46
Printing.....	48
Installing printer software.....	48
Printing a document from Windows.....	48
Printing a document from a Macintosh computer.....	48
Printing the configuration page.....	48
Printing the demo page.....	49
Canceling a print job.....	49
Canceling a print job from the control panel.....	49
Canceling a print job from the Windows taskbar.....	49
Canceling a print job from the Windows desktop.....	49
Canceling a print job from Mac OS 9.....	49
Canceling a print job from Mac OS X.....	50
Copying.....	51
Making a copy.....	51
Customizing copy settings.....	51
Selecting a paper tray for copies.....	51
Selecting a paper size for copies.....	52
Reducing or enlarging copies.....	52
Copying multiple pages onto a single sheet.....	53
Adjusting copy quality.....	53
Making a copy lighter or darker.....	53
Collating copies.....	54
Canceling a copy job.....	54
Scanning.....	55
Scanning a document using the computer.....	55
Scanning documents directly to other applications.....	56
Scanning text for editing.....	56
Customizing scan settings using the computer.....	56
Scanning clear images from magazines or newspapers.....	58
Scanning to a computer over the network.....	58
Setting up the scan directory.....	59
Searching the scan directory.....	59
Canceling a scan job.....	59
Customizing scan settings from the control panel.....	59

Changing the Document Size setting	59
Adjusting the scan resolution.....	59
Making a scanned image lighter or darker	60
Faxing.....	61
Sending a fax.....	61
Sending a fax using the ADF.....	61
Sending a fax using the scanner glass.....	62
Sending a broadcast fax.....	62
Canceling a broadcast fax.....	62
Sending a fax while listening to a call (On Hook Dial).....	63
Sending a fax at the end of a conversation	63
Canceling a fax job	63
Receiving a fax.....	64
Understanding the fax receive modes.....	64
Setting the fax receive mode	64
Receiving a fax at the end of a conversation.....	64
Receiving a fax from an extension telephone.....	65
Adjusting fax activity report settings.....	65
Printing fax activity reports.....	65
Setting up Quick Dial numbers.....	65
Printing the Quick Dial list.....	66
Setting up Speed Dial numbers.....	66
Printing the Speed Dial list.....	66
Understanding the dialing options.....	67
Customizing dial settings.....	67
Setting the dialing mode.....	67
Adjusting the volume	67
Setting the number of rings before receiving a fax automatically.....	68
Setting up to fax while behind a PBX	68
Customizing fax settings.....	69
Making a fax lighter or darker.....	69
Changing the fax resolution.....	69
Setting up real time fax transmission.....	70
Selecting a paper tray for incoming faxes	70
Reducing the print size of an incoming fax.....	70
Clearing jams.....	71
Avoiding jams.....	71
Understanding jam messages and locations.....	71
Clearing Tray 1 jams.....	73
Clearing Tray 2 jams.....	75
Clearing jams behind the rear door.....	76

Paper jam in the ADF.....	77
Understanding printer menus.....	81
Menu list.....	81
Copy Settings menu.....	81
Scan Settings menu.....	83
Fax Settings menu.....	84
Fax Directory menu.....	86
Machine Settings menu.....	87
Network Settings menu.....	90
Reports Print menu.....	90
Admin Settings menu.....	91
Understanding printer messages.....	94
List of status and error messages.....	94
Maintaining the printer.....	99
Storing supplies.....	99
Conserving toner.....	99
Cleaning the printer.....	99
Cleaning the exterior of the printer	99
Cleaning the scanner glass	100
Cleaning the dust-proof glass.....	101
Ordering supplies.....	106
Ordering toner cartridges.....	106
Ordering a fuser.....	107
Ordering a photodeveloper cartridge.....	107
Ordering a waste toner bottle	107
Moving the printer.....	107
Before moving the printer	107
Locking the scanner	108
Removing the printer from the 530-sheet drawer.....	109
Moving the printer to another location	112
Setting the printer up in a new location	112
Administrative support.....	114
Locking the administrator menus.....	114
Changing the administrator menus password.....	114
Adjusting Power Saver.....	114
Restoring factory default settings.....	115
Setting the Default mode.....	115
Turning on Auto Clear.....	116

Using the Embedded Web Server.....	116
Troubleshooting.....	117
Online customer support.....	117
Checking an unresponsive printer.....	117
Solving printing problems.....	117
Multiple-language PDFs do not print	117
Control panel display is blank.....	117
Jobs do not print	117
Job takes longer than expected to print.....	118
Tray linking does not work.....	118
Unexpected page breaks occur.....	118
Solving copy problems.....	119
Copier does not respond	119
Scanner unit does not close	119
Poor copy quality	119
Partial document or photo copies.....	120
Solving scan problems.....	121
Scanner does not respond	121
Scan was not successful	121
Scanning takes too long or freezes the computer	121
Poor scanned image quality	121
Partial document or photo scans.....	122
Cannot scan from a computer	122
Solving fax problems.....	122
Cannot send or receive a fax.....	122
Can send but not receive faxes.....	124
Can receive but not send faxes.....	125
Received fax has poor print quality	125
Solving option problems.....	126
Option does not operate correctly or quits after it is installed.....	126
Drawers	126
Solving paper feed problems.....	127
Paper frequently jams.....	127
Paper jam message remains after jam is cleared	127
Solving print quality problems.....	127
Repeating defects.....	127
Color misregistration.....	128
Light colored line, white line, or incorrectly colored line	128
Smearred vertical print.....	128
Streaked horizontal lines	129
Streaked vertical lines	129
Print is too light.....	130
Print irregularities.....	130
Print is too dark.....	131

Transparency print quality is poor	131
Gray background	131
Uneven print density	132
Ghost images	132
Incorrect margins	132
Skewed print	132
Blank pages	133
Clipped images	133
Solid color pages	134
Paper curl	134
Toner specks	134
Toner rubs off	135
FAQ about color printing	135
Contacting Customer Support	136
Notices	137
Edition notice	137
Power consumption	143
Index	146

Safety information

Connect the power supply cord to a properly grounded electrical outlet that is near the product and easily accessible.

Use only a 26 AWG or larger telecommunications (RJ-11) cord when connecting this product to the public switched telephone network.

Refer service or repairs, other than those described in the user documentation, to a professional service person.

This product is designed, tested, and approved to meet strict global safety standards with the use of specific Lexmark components. The safety features of some parts may not always be obvious. Lexmark is not responsible for the use of other replacement parts.



CAUTION: Make sure that all external connections (such as Ethernet and telephone system connections) are properly installed in their marked plug-in ports.

This product uses a laser.



CAUTION: Use of controls or adjustments or performance of procedures other than those specified herein may result in hazardous radiation exposure.

This product uses a printing process that heats the print media, and the heat may cause the media to release emissions. You must understand the section in your operating instructions that discusses the guidelines for selecting print media to avoid the possibility of harmful emissions.

This product contains mercury in the lamp (<5mg Hg). Disposal of mercury may be regulated due to environmental considerations. For disposal or recycling information, contact your local authorities or the Electronic Industries Alliance: www.eiae.org.

This symbol indicates the presence of a hot surface or component.



CAUTION: To reduce the risk of injury from a hot component, allow the surface to cool before touching it.

Learning about the printer

Configured models

Basic model

The following illustrations show the basic printer model.

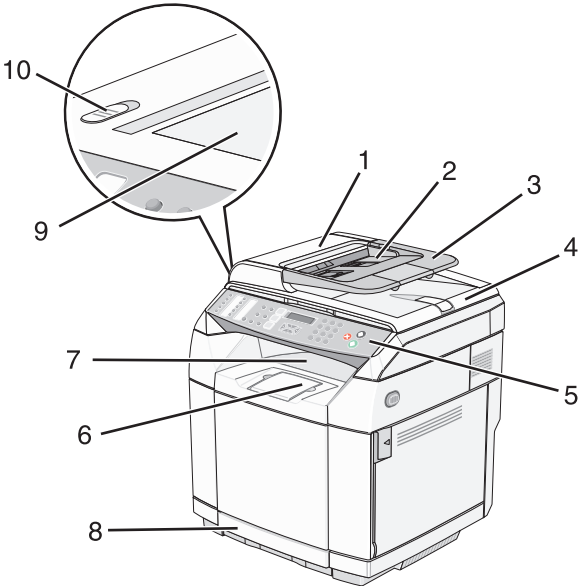

1	Automatic Document Feeder (ADF)
2	Paper guides
3	ADF paper support
4	Scanner cover
5	Control panel
6	Paper support
7	Standard exit bin
8	Standard 250-sheet tray (Tray 1)
9	Scanner glass
10	Scanner lock

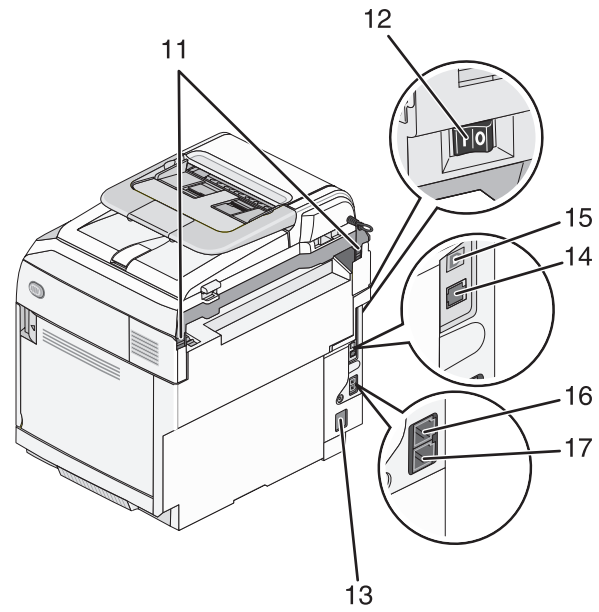

11	Rear hinges
12	Power switch
13	Power supply port
14	Ethernet port
15	USB port
16	EXT port
17	LINE port

Fully configured model

The following illustration shows the fully configured printer model. The basic model can be fully configured by adding a 530-sheet drawer. The asterisk (*) indicates the drawer is optional.



1	Optional 530-sheet drawer (Tray 2)*
---	-------------------------------------

Understanding the control panel

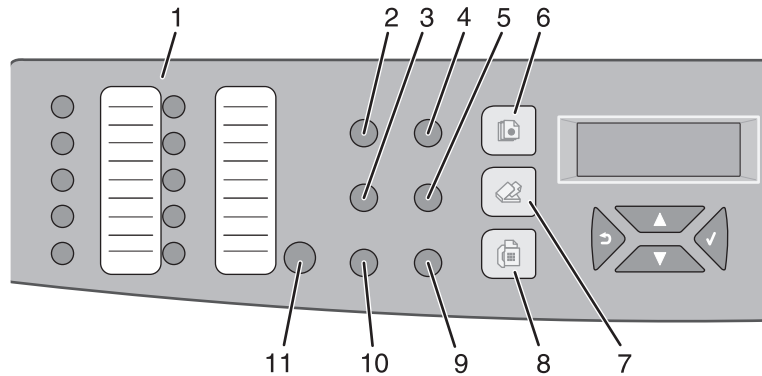

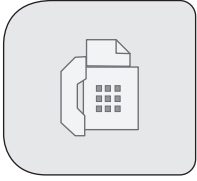

Control panel item		Description
1	Quick access panel	<p>The buttons on the quick access panel provide direct access to pre-programmed fax numbers and scan destinations.</p> <ul style="list-style-type: none"> Up to 20 entries can be stored in the Quick Dial directory for one-touch access to fax numbers. <p>Note: You can set up Quick Dial entries using the control panel.</p> <ul style="list-style-type: none"> Up to 20 entries can be stored in the One Touch Button directory for one-touch access to e-mail addresses, FTP destinations, or computer destinations. <p>Note: You can set up One Touch Button entries using the Embedded Web Server.</p>
2	Redial / Pause	<ul style="list-style-type: none"> Dial the last fax number entered (redial). Insert a three-second pause in the number to be dialed to wait for an outside line or get through an automated answering system.
3	Hook	Toggle the phone line on (for manual faxing) or off (for automatic faxing).
4	Reduce / Enlarge	Adjust the size of a copied document as compared to its original size (25%–400%).
5	Lighter / Darker	Increase or decrease the intensity of an image when copying or scanning.
6	Copy	Activate Copy mode.
7	Scan	Activate Scan mode.

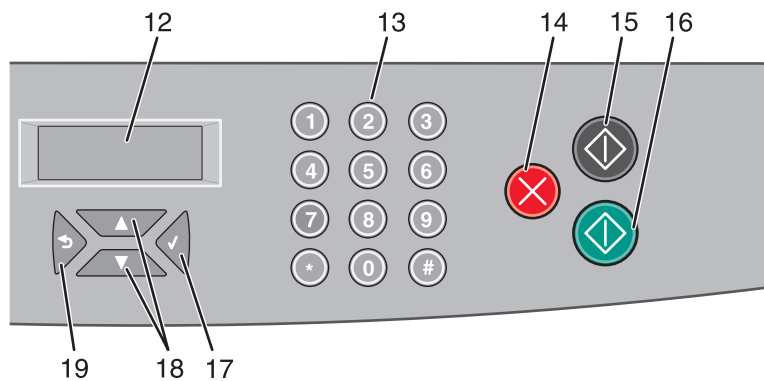
Control panel item		Description
8	Fax 	Activate Fax mode. Note: The Fax function is not available on all models.
9	Image quality	Access the copy, scan, and fax quality options.
10	Directory	Access pre-programmed fax numbers and scan destinations. <ul style="list-style-type: none"> Up to 50 entries can be stored in the Speed Dial directory. Up to 20 entries can be stored in the Scan directory.
11	Shift	Access Quick Dial numbers 11–20 by pressing the Shift button and then pressing the Quick Dial button that corresponds to the number you want to access.

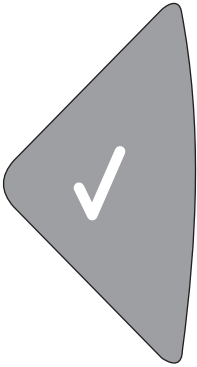
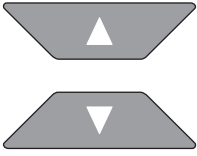
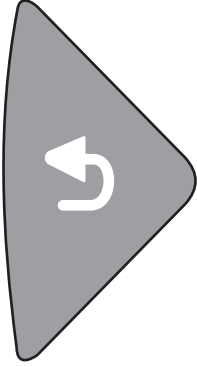

Control panel item		Description
12	Display	Shows messages describing the current state of the printer and indicating possible printer problems you must resolve
13	Keypad	In Copy mode: Enter the number of copies or prints you want to make. In Fax mode: <ul style="list-style-type: none"> Enter fax numbers. Select letters when creating a Speed Dial list. Type numbers to enter or edit the date and time shown on the display.
14	Stop / Clear 	Reset the printer when performing an action, or return the printer to Ready when navigating the menus.

Control panel item		Description
15	Black Start 	Start copying or scanning in black and white.
16	Color Start 	Start copying or scanning in color.
17	Select 	Accept menu selections and settings.
18	Navigation buttons 	<ul style="list-style-type: none"> • Press ▲ or ▼ to scroll through menu lists. • When Ready appears on the display, press ▲ or ▼ to enter the menus.
19	Back 	Return to the previous menu.

Getting the printer ready to fax

The following connection methods may not be applicable in all countries or regions.

 **CAUTION:** Do not use the fax feature during a lightning storm. Do not set up this product or make any electrical or cabling connections, such as the power supply cord or telephone, during a lightning storm.

Choosing a fax connection

You can connect the printer with equipment such as a telephone, an answering machine, or a computer modem.

Note: The printer is an analog device that works best when directly connected to the wall jack. Other devices (such as a telephone or answering machine) can be successfully attached to pass through the printer, as described in the setup steps. If you want a digital connection such as ISDN, DSL, or ADSL, a third-party device (such as a DSL filter) is required.

You *do not* need to attach the printer to a computer, but you *do* need to connect it to a telephone line to send and receive faxes.

You can connect the printer to other equipment. See the following table to determine the best way to set up the printer.

Equipment	Benefits
<ul style="list-style-type: none">• The printer• A telephone cord	Send and receive faxes without using a computer.
<ul style="list-style-type: none">• The printer• A telephone• Two telephone cords	<ul style="list-style-type: none">• Use the fax line as a normal telephone line.• Send and receive faxes without using a computer.
<ul style="list-style-type: none">• The printer• A telephone• An answering machine• Three telephone cords	Receive both incoming voice messages and faxes.
<ul style="list-style-type: none">• The printer• A telephone• A computer modem• Three telephone cords	Send faxes using the computer or the printer.

Using an RJ11 adapter

Country/region

- United Kingdom
- Ireland
- Finland
- Norway
- Denmark
- Italy
- Sweden
- Netherlands
- France
- Portugal

To connect your printer to an answering machine, telephone, or other telecommunications equipment, use the telephone line adapter included in the box with the printer in some countries or regions.

Note: If you have DSL, do not connect the printer using a splitter because the fax feature may not work correctly.

- 1 Connect the adapter to the telephone cord that came with the printer.

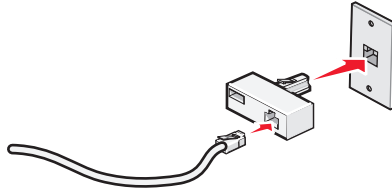

Note: The UK adapter is shown. Your adapter may look different, but it will fit the telephone outlet used in your location.

- 2 Connect the telephone line of your chosen telecommunications equipment to the left outlet of the adapter.

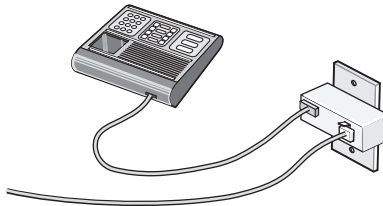

If your telecommunications equipment uses a US-style (RJ11) telephone line, follow these steps to connect the equipment:

- 1 Remove the plug from the EXT port  on the back of the printer.

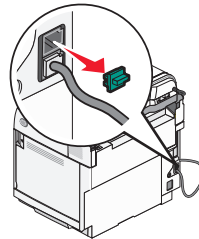

Note: Once this plug is removed, any country- or region-specific equipment you connect to the printer by the adapter, as shown, will not function properly.

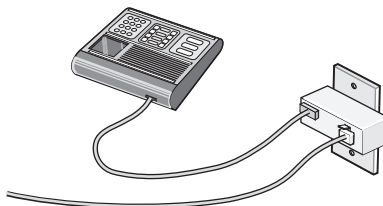

- 2 Connect your telecommunications equipment directly to the EXT port  on the back of the printer.

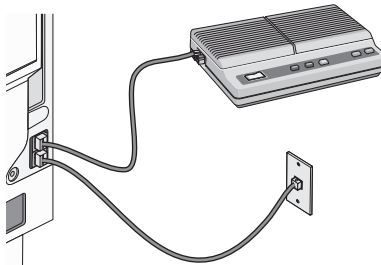

Warning: Do not touch cables or the printer in the area shown while actively sending or receiving a fax.

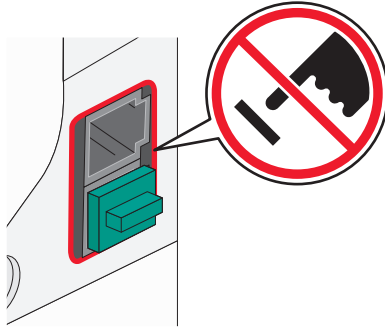

Country/region

- Saudi Arabia
- United Arab Emirates
- Egypt
- Bulgaria
- Czech Republic
- Belgium
- Australia
- South Africa
- Greece
- Israel
- Hungary
- Poland
- Romania
- Russia
- Slovenia
- Spain
- Turkey

To connect a telephone, an answering machine, or other telecommunications equipment to the printer:

- 1 Remove the plug from the back of the printer.

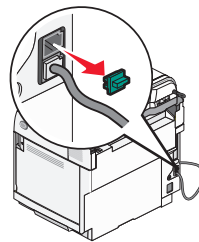

- 2 Connect your telecommunications equipment directly to the EXT port  on the back of the printer.

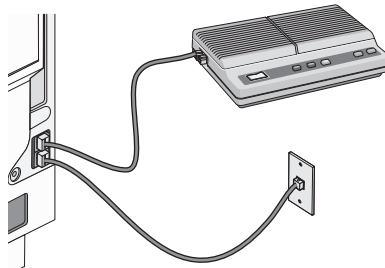

Note: Once this plug is removed, any country- or region-specific equipment that you connect to the printer by the adapter, as shown, will not function properly.

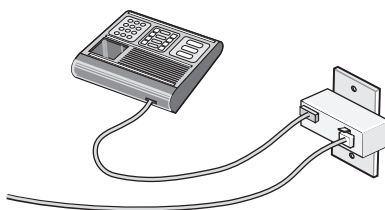

Country/region

- Germany
- Austria
- Switzerland

There is a plug installed in the EXT port  of the printer. This plug is necessary for the proper functioning of the printer.

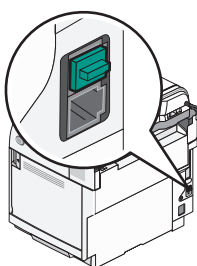

Note: Do not remove the plug. If you remove it, other telecommunications devices in your home (such as telephones or answering machines) may not work.

Connecting directly to a telephone wall jack

Connect the printer directly to a telephone wall jack to make copies or to send and receive faxes without using a computer.

- 1 Make sure you have a telephone cord and a telephone wall jack.
- 2 Connect one end of the telephone cord into the LINE port  of the printer.

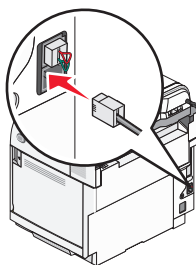

- 3 Connect the other end of the telephone cord into an active telephone wall jack.

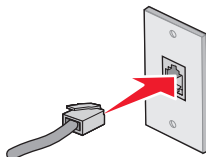

Connecting directly to a telephone wall jack in Germany

Connect the printer directly to a telephone wall jack to send and receive faxes without using a computer.

Note: In Germany (and some other countries), the printer ships with a special RJ-11 plug in the EXT port. Do not remove the RJ-11 plug. It is required for both the fax and telephone to work properly.

- 1** Make sure you have a telephone cord (provided with the product) and a telephone wall jack.
- 2** Connect one end of the telephone cord into the LINE port of the printer.

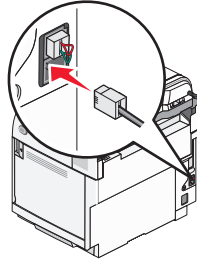

- 3** Connect the other end of the telephone cord into the N slot of an active telephone wall jack.

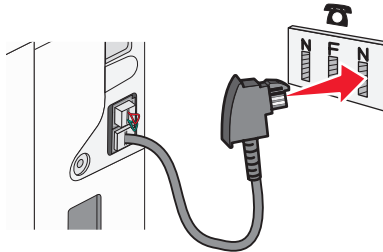

- 4** If you would like to use the same line for both fax and telephone communication, connect a second telephone line (not provided) between the telephone and the F slot of an active telephone wall jack.

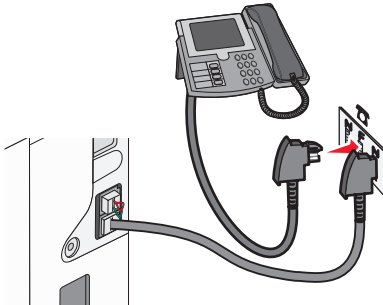

- 5 If you would like to use the same line for recording messages on your answering machine, connect a second telephone line (not provided) between the answering machine and the other N slot of the telephone wall jack.

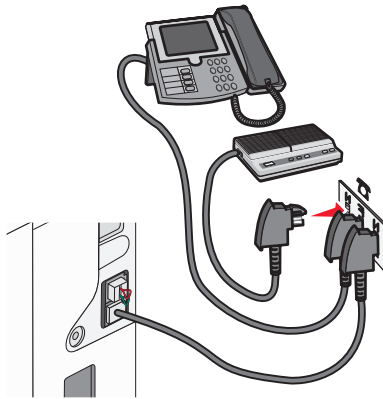

Connecting to a telephone

Connect a telephone to the printer to use the fax line as a normal telephone line. Then set up the printer wherever your telephone is located to make copies or to send and receive faxes without using a computer.

Note: Setup steps may vary depending on your country or region.

- 1 Make sure you have the following:

- A telephone
- Two telephone cords
- A telephone wall jack

- 2 Connect one telephone cord to the LINE port  of the printer, and then plug it into an active telephone wall jack.

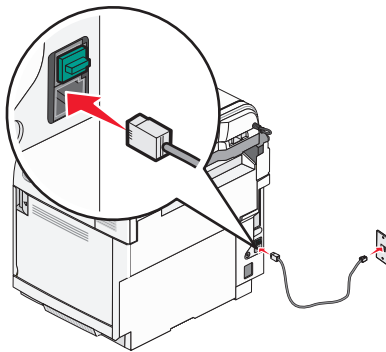

3 Remove the protective plug from the EXT port  of the printer.

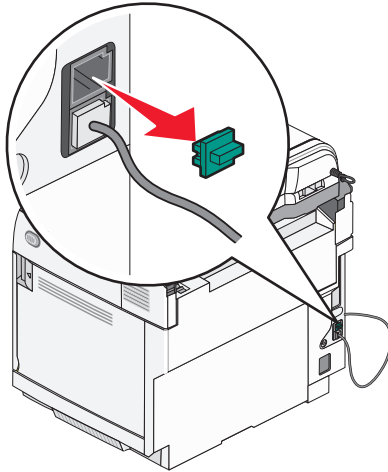

4 Connect the other telephone cord to a telephone, and then plug it into the EXT port  of the printer.

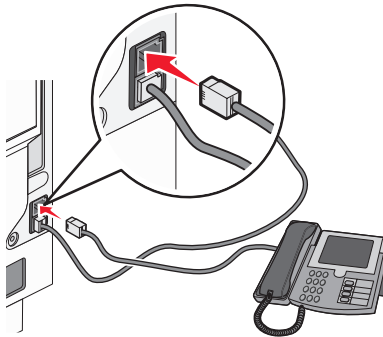

Connecting to an answering machine

Connect an answering machine to the printer to receive both incoming voice messages and faxes.

Note: Setup steps may vary depending on your country or region.

1 Make sure you have the following:

- A telephone
- An answering machine
- Three telephone cords
- A telephone wall jack

2 Connect one telephone cord into the LINE port  of the printer, and then plug it into an active telephone wall jack.

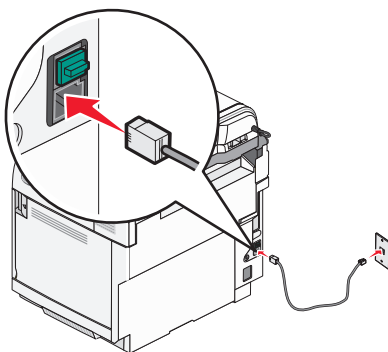

3 Remove the protective plug from the EXT port  of the printer.

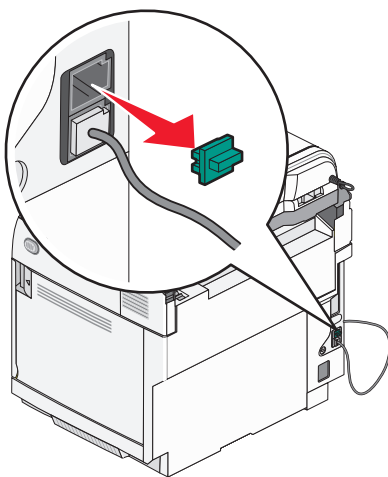

4 Connect a second telephone cord from the telephone to the answering machine.



5 Connect a third telephone cord from the answering machine to the EXT port  of the printer.

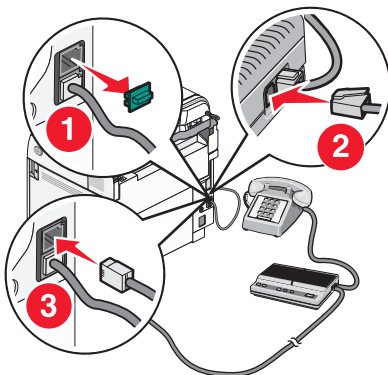

Connecting to a computer with a modem

Connect the printer to a computer with a modem to send faxes from the software program.

Note: Setup steps may vary depending on your country or region.

1 Make sure you have the following:

- A telephone
- A computer with a modem
- Three telephone cords
- A telephone wall jack

2 Connect a telephone cord into the LINE  port of the printer, and then plug it into an active telephone wall jack.

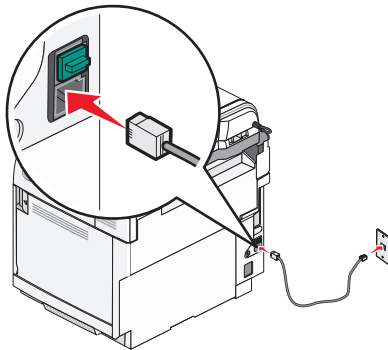

3 Remove the protective plug from the EXT port  of the printer.

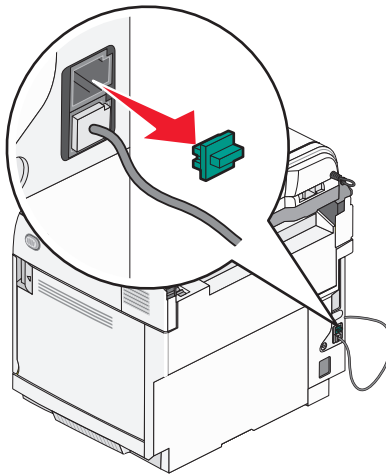

4 Connect a second telephone cord from the telephone to the computer modem.

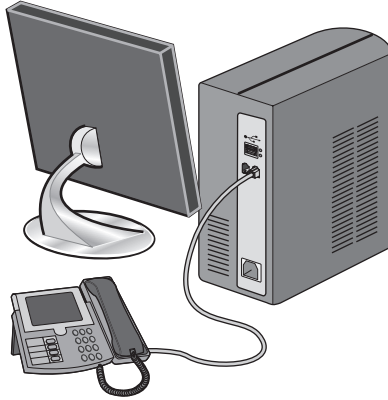

5 Connect a third telephone cord from the computer modem to the EXT port of the printer.

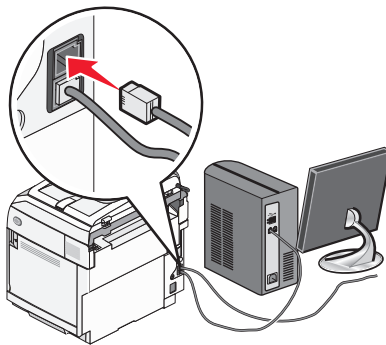

Setting the outgoing fax name and number

To have the designated fax name and fax number printed on outgoing faxes:

- 1 From the control panel, press ▲.
- 2 Press ▲ or ▼ repeatedly until **Admin Settings** appears, and then press √.
- 3 Press ▲ or ▼ repeatedly until **User Settings** appears, and then press √.
- 4 Press ▲ or ▼ repeatedly until **User Fax #** appears, and then press √.
- 5 Use the keypad to enter the fax number, and then press √.
- 6 Press ▲ or ▼ repeatedly until **User Name** appears, and then press √.
- 7 Use the keypad to type the user name, and then press √.
- 8 Press ✖ to return to the **Ready** state.

Setting the date

You can set the date so that the correct date is printed on every fax you send. If there is a power failure, you may have to reset the date. To set the date:

- 1 From the control panel, press ▲.
- 2 Press ▲ or ▼ repeatedly until **Admin Settings** appears, and then press √.

- 3 Press ▲ or ▼ repeatedly until **Date/Time Setup** appears, and then press √.
- 4 Press ▲ or ▼ repeatedly until **Date Setting** appears, and then press √.
- 5 Press ▲ or ▼ repeatedly until **Year, Month, Date, or Date Format** appears, and then press √.
- 6 Press ▲ or ▼ repeatedly, or use the keypad, to adjust the date item selected, and then press √.
- 7 Press ↶ to adjust another date item; otherwise, press ❌ to return to the **Ready** state.

Setting the time

You can set the time so that the correct time is printed on every fax you send. If there is a power failure, you may have to reset the time. To set the time:

- 1 From the control panel, press ▲.
- 2 Press ▲ or ▼ repeatedly until **Admin Settings** appears, and then press √.
- 3 Press ▲ or ▼ repeatedly until **Date/Time Setup** appears, and then press √.
- 4 Press ▲ or ▼ repeatedly until **Time Setting** appears, and then press √.
- 5 Press ▲ or ▼ repeatedly until **Time Format, Hour, or Minute** appears, and then press √.
- 6 Press ▲ or ▼ repeatedly, or use the keypad, to adjust the time item selected, and then press √.
- 7 To adjust another time item, press ↶, otherwise press ❌ to return to the **Ready** state.

Installing options

Installing a 530-sheet drawer

The printer supports one optional drawer which allows an additional 530 sheets of paper to be loaded.

 **CAUTION:** If you are installing a 530-sheet drawer after setting up the printer, turn the printer off, and unplug the power cord before continuing.

- 1 Unpack the 530-sheet drawer, and remove any packing material.
- 2 Place the drawer in the location chosen for the printer.
- 3 Align the printer with the 530-sheet drawer, and lower the printer into place.

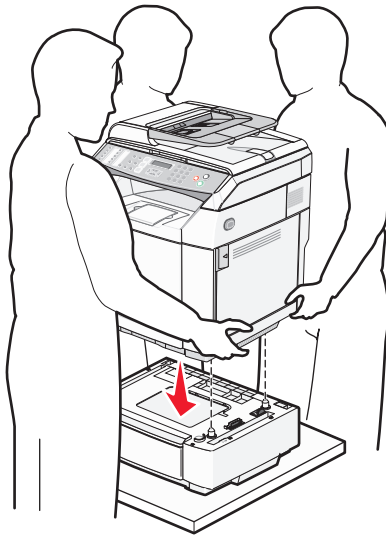

Securing the 530-sheet drawer to the printer

1 Align one bracket with the hole on the right side of the printer as shown. Press the bracket flat against the printer, and then tighten the thumbscrew.

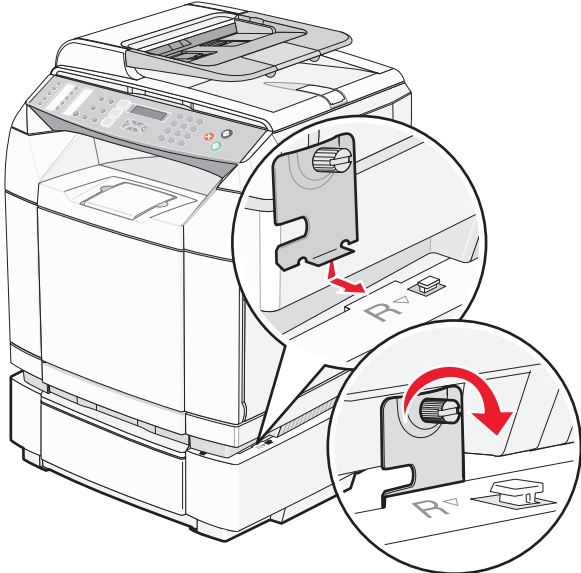

2 Starting at the front of the printer, push the right side cover onto the printer, fitting each slot on the cover over its corresponding tab on the drawer in order to cover the gap between the printer and the drawer.

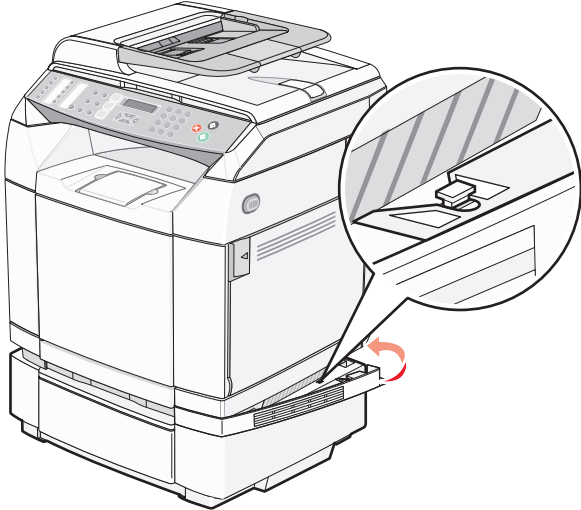

- 3** Align the other bracket with the hole on the left side of the printer as shown. Press the bracket flat against the printer, and then tighten the thumbscrew.

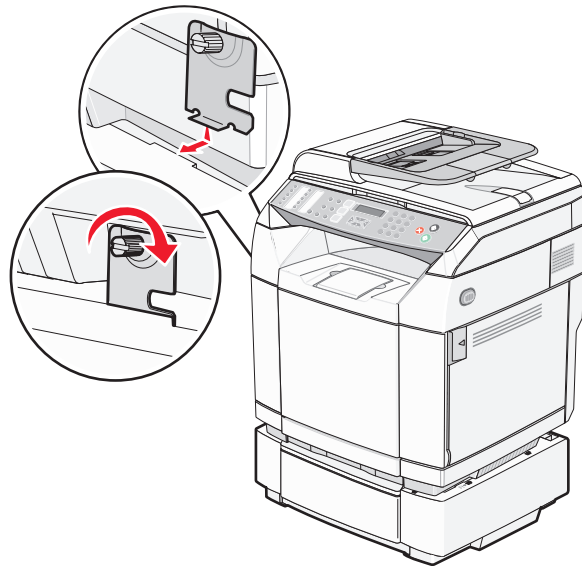

- 4** Starting at the front of the printer, push the left side cover onto the printer, fitting each slot on the cover over its corresponding tab on the drawer in order to cover the gap between the printer and the drawer.

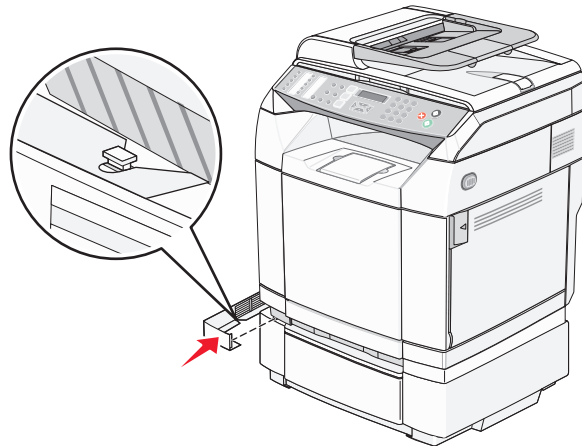

Attaching cables

Connect the printer to the computer using a USB cable or an Ethernet cable.

- A USB port requires a USB cable. Be sure to match the USB symbol on the cable with the USB symbol on the printer.
- Connect the Ethernet cable to the Ethernet port shown.

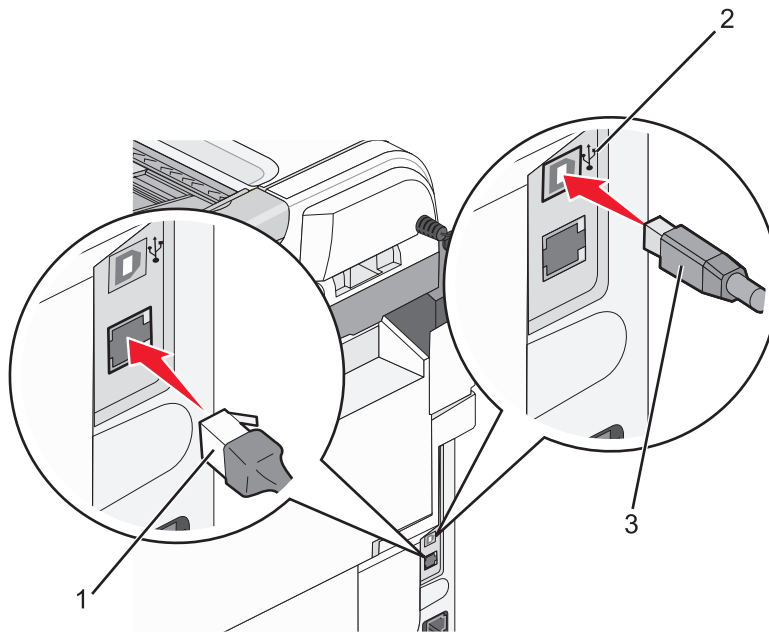

1	Ethernet port
2	USB symbol
3	USB port

Loading paper and specialty media

This section shows how to load the standard tray (250-sheet tray) and the optional 530-sheet tray which is part of the optional 530-sheet drawer. It also includes information about the standard exit bin.

Loading trays

The printer has two trays to select from: the standard tray (Tray 1), also known as the 250-sheet tray, and the optional 530-sheet tray (Tray 2), which is part of the 530-sheet drawer and fits into the support unit. Load the paper or specialty media used for the majority of print jobs in Tray 1. Proper paper loading prevents jams and facilitates trouble-free printing.

Note: Tray 1 can be used as a letter-size tray or may be extended to a legal-size tray.

Load the standard tray or optional trays in the same way. The width and length guide tabs look different; however, all of them squeeze and move in the same manner.

- 1 Grasp the handle, and pull the tray out. Remove the tray completely.

Note: Do not remove trays while a job prints or while **Please wait** blinks on the display. Doing so may cause a jam.

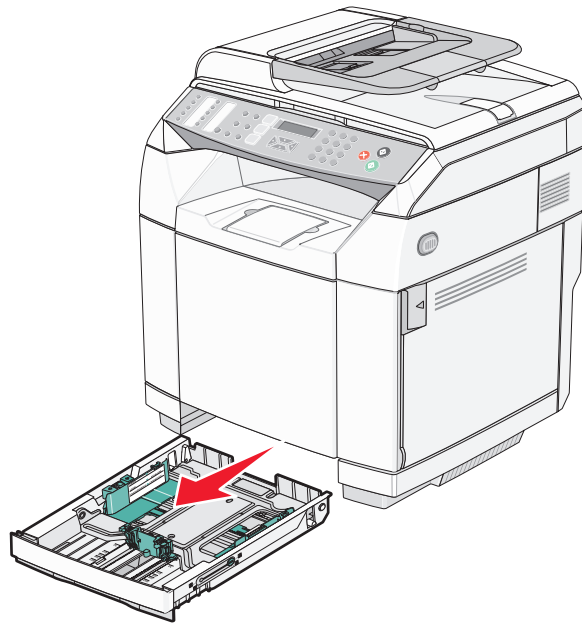

- 2 Squeeze the length guide tabs together as shown. Slide the guide to the correct position for the paper size being loaded.

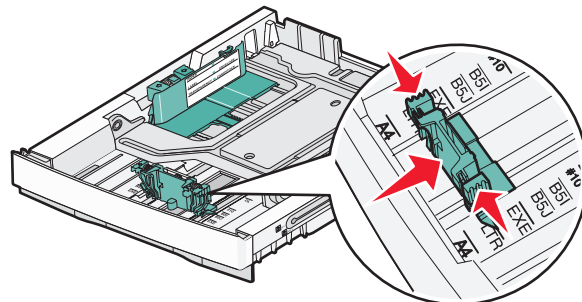

Note: Notice the size indicators on the bottom of the tray on both sizes of the guide. Use these indicators for help positioning the guide.

This second illustration shows the tabs and size indicators for the optional 530-sheet tray.

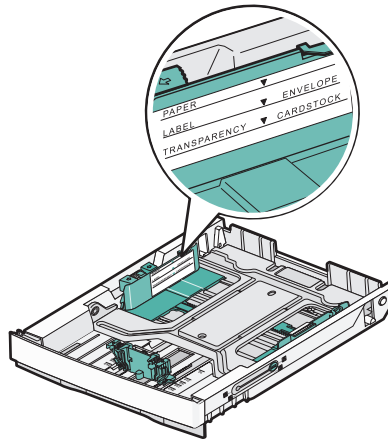

- 3 Squeeze the width guide tabs together as shown, and slide the width guide to the correct position for the paper size being loaded.

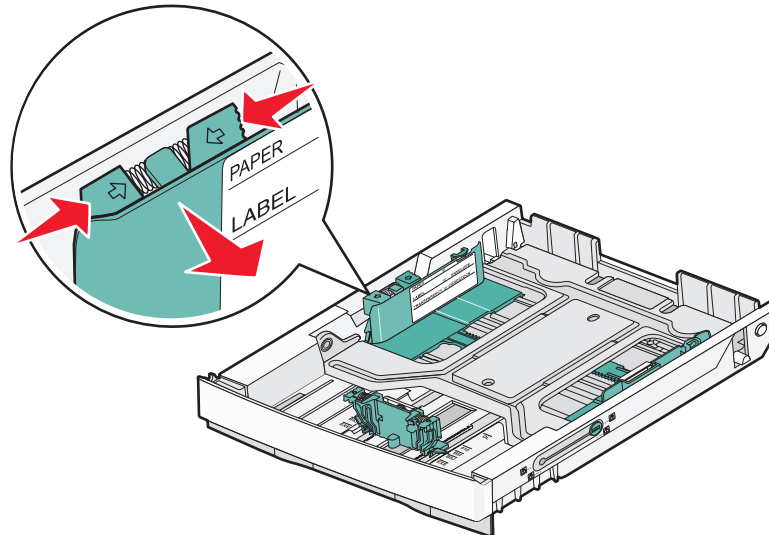

Note: Notice the size indicators on the bottom left of the tray. Use these indicators for help positioning the guide. Notice the load line label on the side of the tray which indicates the maximum stack height for your paper.

This second illustration shows the tabs, the size indicators, and the load line for the optional 530-sheet tray.

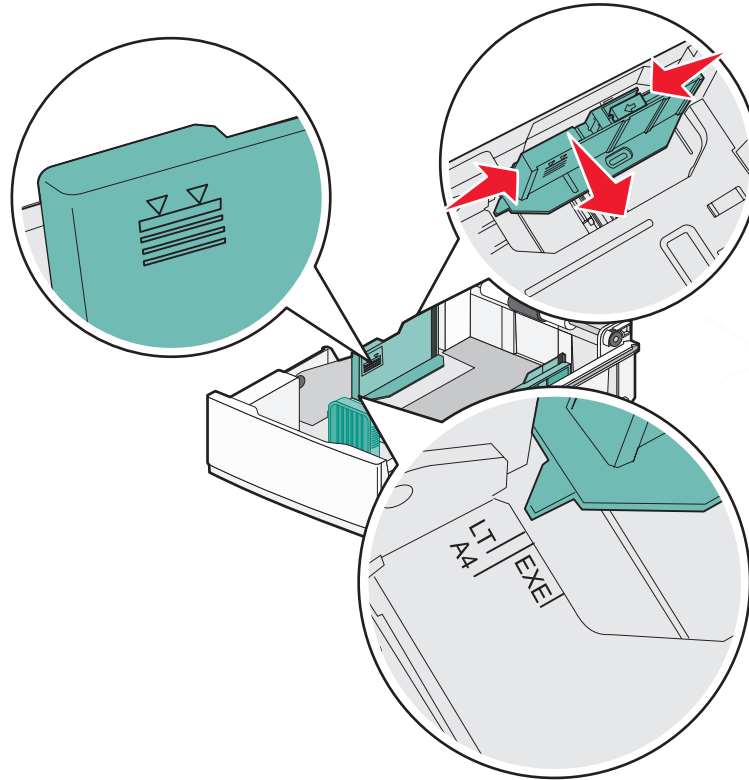

- 4** Flex the sheets back and forth to loosen them, and then fan them. Do not fold or crease the paper. Straighten the edges on a level surface.

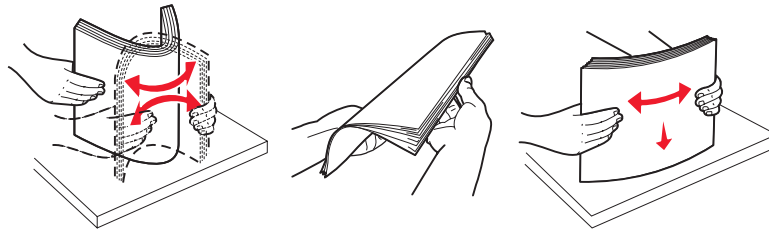

- 5** Load the paper stack with the recommended print side faceup. Load the stack toward the back of the tray as shown.

When loading preprinted letterhead, place the header toward the rear of the tray.

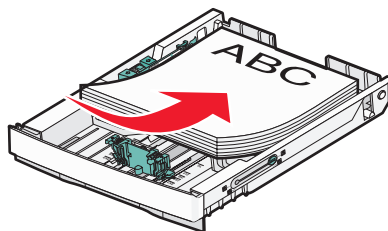

6 Align the tray, and insert it.

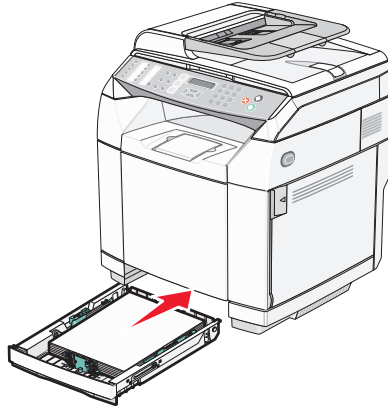

Converting the standard tray to a legal-size tray

The standard tray (Tray 1), also known as the 250-sheet tray, can be extended to make the 250-sheet legal-size tray (Tray 1).

Note: Not all models come with a universal tray. You may need to purchase a legal-size tray separately.

To extend the standard tray:

- 1 Grasp the handle, and pull the tray out. Remove the tray completely.

Note: Do not remove trays while a job prints or while **Please wait** blinks on the display. Doing so may cause a jam.

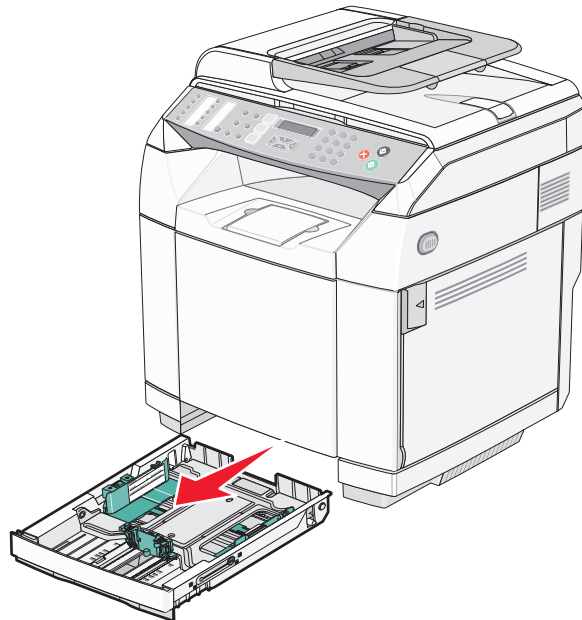

2 Using a coin or a flat head screwdriver, unlock the tray on each side.

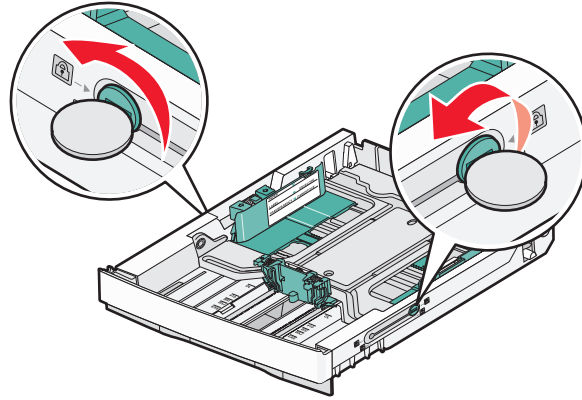

3 Fully extend the tray until the locking tabs are in the LGL position.

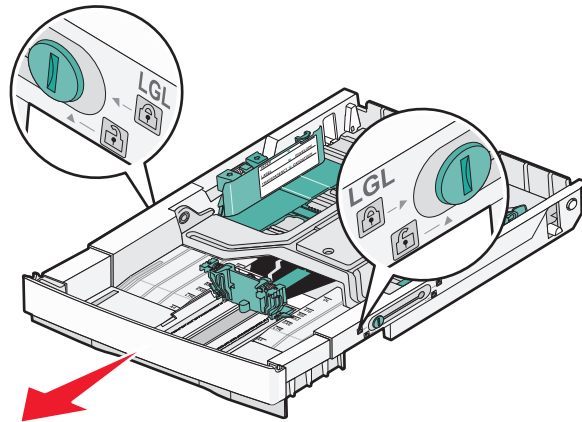

4 Lock the tray on each side.

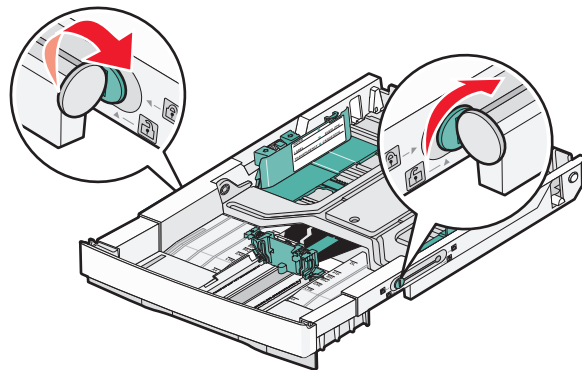

5 Slide the paper guide to the legal position.

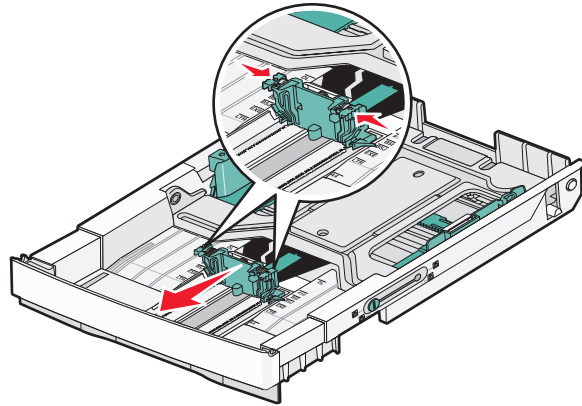

6 Attach the dust cover.

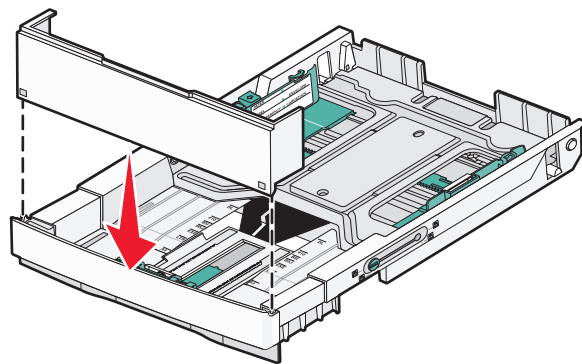

7 Load the paper stack with the recommended print side faceup, and close the dust cover.
When loading preprinted letterhead, place the header toward the rear of the tray.

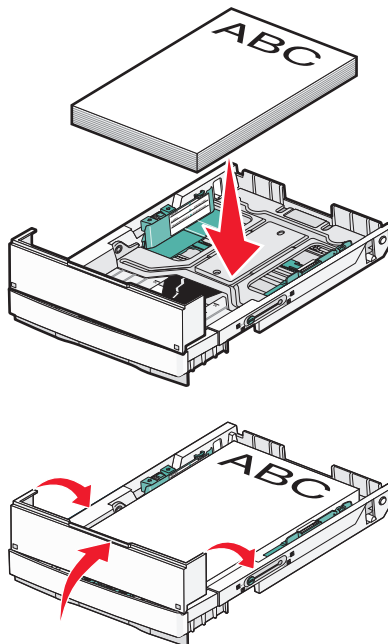

- 8 Align the tray, and insert it.

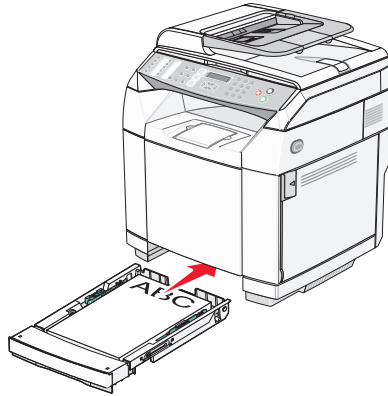

Setting the Paper Type

- 1 Make sure the printer is on and **Ready** appears.
- 2 From the control panel, press ▲.
- 3 Press ▲ or ▼ repeatedly until **Machine Settings** appears, and then press √.
- 4 Press ▲ or ▼ repeatedly until **Paper Settings** appears, and then press √.
- 5 Press ▲ or ▼ repeatedly until **Paper Type** appears, and then press √.
- 6 Press ▲ or ▼ repeatedly to select either **Tray1 Paper** or **Tray2 Paper**, and then press √.
- 7 Press ▲ or ▼ repeatedly until the Paper Type you want appears, and then press √.
- 8 Press ✖ to return to the **Ready** state.

Setting up the standard exit bin

The standard exit bin holds up to 250 sheets of 20 lb paper. It collects print jobs facedown.

The standard exit bin collects every type of paper and specialty media the printer supports.

To set up the standard exit bin:

- 1 Grasp the edges of the paper support at the indentations in the exit bin.
- 2 Lift the paper support.

3 Lower the paper support into place so that it is now at an angle.



The paper support is inclined so the paper now remains in a neater stack in the standard exit bin.

Note: Do not leave the paper support inclined if you are printing transparencies. Doing so may cause creases in the transparencies.

Linking trays

Tray linking enables the automatic linking feature for trays when the same size and type of paper is loaded in multiple sources. By linking trays, you can create a larger capacity for output. When Tray 1 is empty, paper automatically feeds from Tray 2 to finish printing.

To set up tray linking:

- Load both Tray 1 and Tray 2 with the same paper size and type.
- From Print Properties, change the Paper source to Auto select.

Paper and specialty media guide

Paper guidelines

When printing on specialty media, use the printer control panel to set the correct Paper Type.

Paper characteristics

The following paper characteristics affect print quality and reliability. Consider these characteristics when evaluating new paper stock.

Weight

The printer can automatically feed paper weights from 60 to 176 g/m² (16 to 47 lb bond) grain long. Paper lighter than 60 g/m² (16 lb) might not be stiff enough to feed properly, causing jams. For best performance, use 90 g/m² (24 lb bond) grain long paper. For paper smaller than 182 x 257 mm (7.2 x 10.1 in.), we recommend 90 g/m² or heavier paper.

Curl

Curl is the tendency for paper to curl at its edges. Excessive curl can cause paper feeding problems. Curl can occur after the paper passes through the printer, where it is exposed to high temperatures. Storing paper unwrapped in hot, humid, cold, or dry conditions, even in the trays, can contribute to paper curling prior to printing and can cause feeding problems.

Smoothness

Paper smoothness directly affects print quality. If paper is too rough, toner cannot fuse to it properly. If paper is too smooth, it can cause paper feeding or print quality issues. Always use paper between 100 and 300 Sheffield points; however, smoothness between 150 and 200 Sheffield points produces the best print quality.

Moisture content

The amount of moisture in paper affects both print quality and the ability of the printer to feed the paper correctly. Leave paper in its original wrapper until it is time to use it. This limits the exposure of paper to moisture changes that can degrade its performance.

Condition paper before printing by storing it in its original wrapper in the same environment as the printer for 24 to 48 hours before printing. Extend the time several days if the storage or transportation environment is very different from the printer environment. Thick paper may also require a longer conditioning period.

Grain direction

Grain refers to the alignment of the paper fibers in a sheet of paper. Grain is either *grain long*, running the length of the paper, or *grain short*, running the width of the paper.

For 60 to 90 g/m² (16 to 24 lb bond) paper, use grain long fibers.

Fiber content

Most high-quality xerographic paper is made from 100% chemically treated pulped wood. This content provides the paper with a high degree of stability resulting in fewer paper feeding problems and better print quality. Paper containing fibers such as cotton possesses characteristics that can negatively affect paper handling.

Unacceptable paper

The following paper types are not recommended for use with the printer:

- Chemically treated papers used to make copies without carbon paper, also known as carbonless papers, carbonless copy paper (CCP), or no carbon required (NCR) paper
- Preprinted papers with chemicals that may contaminate the printer
- Preprinted papers that can be affected by the temperature in the printer fuser
- Preprinted papers that require a registration (the precise print location on the page) greater than ± 2.3 mm (± 0.9 in.), such as optical character recognition (OCR) forms

In some cases, registration can be adjusted with a software application to successfully print on these forms.

- Coated papers (erasable bond), synthetic papers, thermal papers
- Rough-edged, rough or heavily textured surface papers, or curled papers
- Recycled papers containing more than 25% post-consumer waste that do not meet DIN 19 309
- Paper weighing less than 60 g/m² (16 lb)
- Multiple-part forms or documents

Selecting paper

Using appropriate paper prevents jams and helps ensure trouble-free printing.

To help avoid jams and poor print quality:

- *Always* use new, undamaged paper.
- Before loading paper, know the recommended print side of the paper. This information is usually indicated on the paper package.
- *Do not* use paper that has been cut or trimmed by hand.
- *Do not* mix paper sizes, types, or weights in the same source; mixing results in jams.
- *Do not* use coated papers unless they are specifically designed for electrophotographic printing.

Selecting preprinted forms and letterhead

Use these guidelines when selecting preprinted forms and letterhead:

- Use grain long papers for best results for 60 to 90 g/m² weights.
- Use only forms and letterhead printed using an offset lithographic or engraved printing process.
- Avoid papers with rough or heavily textured surfaces.

User papers printed with heat-resistant inks designed for use in xerographic copiers. The ink must be able to withstand temperatures up to 180°C (356°F) without melting or releasing hazardous emissions. Use inks that are not affected by the resin in toner. Inks that are oxidation-set or oil-based generally meet these requirements; latex inks might not. When in doubt, contact the paper supplier.

Preprinted papers such as letterhead must be able to withstand temperatures up to 180°C (356°F) without melting or releasing hazardous emissions

Using letterhead

Check with the manufacturer or vendor to determine whether the chosen preprinted letterhead is acceptable for laser printers.

Page orientation is important when printing on letterhead. Use the following table for help when loading letterhead:

Paper source	Print side	Top of page
Tray 1 (250-sheet tray) Note: Tray 1 can be adjusted to fit either letter- or legal-size paper.	Letterhead faceup	Letterhead goes toward the rear of the tray
Tray 2 (Optional 530-sheet tray)	Letterhead faceup	Letterhead goes toward the rear of the tray

Using transparencies

Print samples on the transparencies being considered for use before buying large quantities.

When printing on transparencies:

- From Print Properties, or the control panel, set the Paper type to Transparency.
Warning: Not setting the Paper type to Transparency could damage the printer.
- Feed transparencies from the standard tray (Tray 1).
- Use transparencies designed specifically for laser printers. Check with the manufacturer or vendor to ensure transparencies are able to withstand temperatures up to 180°C (356°F) without melting, discoloring, offsetting, or releasing hazardous emissions.
- Use transparencies that are 0.12–0.14 mm (4.8–5.4 mil) in thickness or 161–179 g/m² in weight. Print quality and durability depend on the transparencies used.
- To prevent print quality problems, avoid getting fingerprints on the transparencies.
- Before loading transparencies, fan the stack to prevent sheets from sticking together.
- We recommend Lexmark part number 12A8240 for letter-size and Lexmark part number 12A8241 for A4-size transparencies.

Using envelopes

You can load up to 10 envelopes in the standard tray. Print samples on the envelopes being considered for use before buying large quantities.

When printing on envelopes:

- From Print Properties or the control panel, set the Paper Size and Paper Type.
- Use envelopes designed specifically for laser printers. Check with the manufacturer or vendor to ensure the envelopes can withstand temperatures up to 180°C (356°F) without sealing, wrinkling, curling excessively, or releasing hazardous emissions.
- For the best performance, use envelopes made from 90 g/m² (24 lb bond) paper. Use up to 105 g/m² (28 lb bond) weight for envelopes as long as the cotton content is 25% or less. All-cotton envelopes must not exceed 90 g/m² (24 lb bond) weight.
- Use only new envelopes.
- If wrinkling or smeared print occurs, use the Print Properties to rotate the orientation of the envelope by 180 degrees, and then try printing again.
- To optimize performance and minimize jams, do not use envelopes that:
 - Have excessive curl or twist
 - Are stuck together or damaged in any way
 - Have windows, holes, perforations, cutouts, or embossing
 - Have metal clasps, string ties, or folding bars
 - Have an interlocking design

- Have postage stamps attached
- Have any exposed adhesive when the flap is in the sealed or closed position
- Have bent corners
- Have rough, cockle, or laid finishes
- Adjust the width guide to fit the width of the envelopes.
- Load only one size of envelope at a time in the tray. Envelopes may only be loaded in the standard tray. Load them with the flap down and to the left of the tray.
- Use only envelopes with a flap that covers the area where the seams come together. For more information, see the following illustrations:

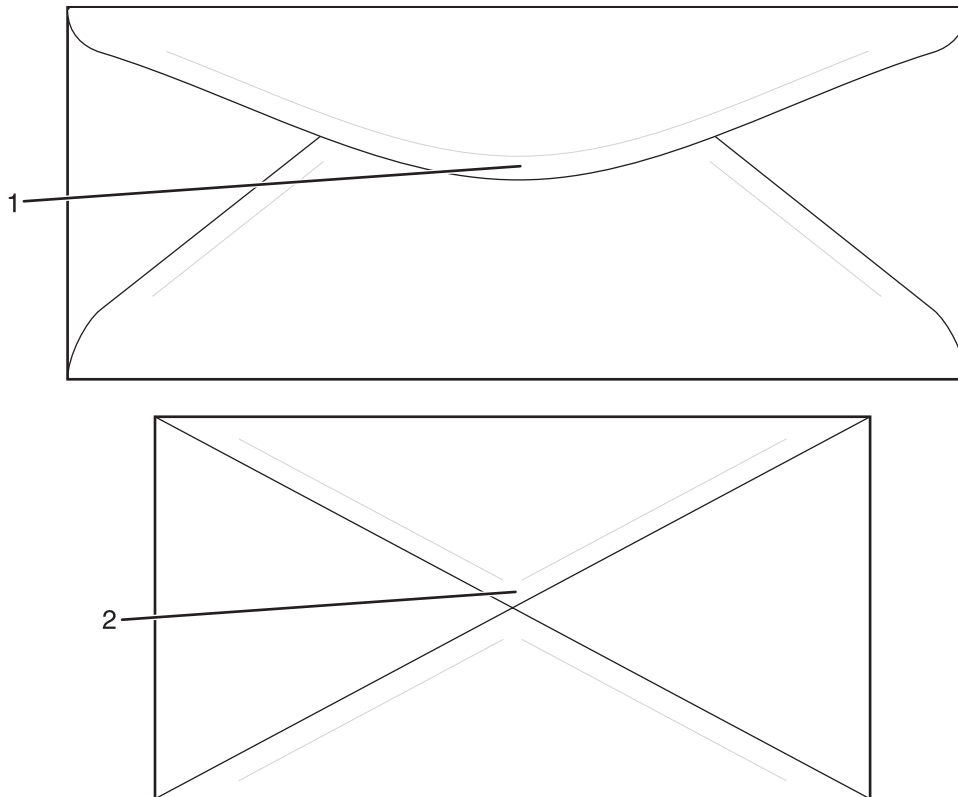

1	Envelope flap covering seams (supported)
2	Exposed seams (unsupported)

Note: A combination of high humidity (over 60%) and the high printing temperature may wrinkle or seal envelopes.

Using labels

Print samples on the labels being considered for use before buying large quantities.

For detailed information on label printing, characteristics, and design, see the *Card Stock & Label Guide* available on the Lexmark Web site at www.lexmark.com/publications.

When printing on labels:

- From Print Properties, or the control panel, set the Paper type to Labels.
- Do not load labels together with paper or transparencies in the same source; mixing media can cause feeding problems.
- Use only letter-, A4-, and legal-size label sheets.

- Use labels designed specifically for laser printers, except vinyl labels. Check with the manufacturer or vendor to verify that label adhesives, face sheet (printable stock), and topcoats can withstand temperatures up to 180° C (356°F) and pressure up to 30 psi without delaminating, oozing around the edges, or releasing hazardous fumes. Do not use vinyl labels.
- Do not use labels with slick backing material.
- Use full label sheets. Partial sheets may cause labels to peel off during printing, resulting in a jam. Partial sheets also contaminate the printer and the cartridge with adhesive, and could void the printer and cartridge warranties.
- Do not print within 1 mm (0.04 in.) of the edge of the label, of the perforations, or between die-cuts of the label.
- Be sure adhesive backing does not reach to the sheet edge. Zone coating of the adhesive at least 1 mm (0.04 in.) away from edges is recommended. Adhesive material contaminates the printer and could void the warranty.
- If zone coating of the adhesive is not possible, remove a 3 mm (0.125 in.) strip on the leading and driver edge, and use a non-oozing adhesive.
- Portrait orientation works best, especially when printing bar codes.
- Do not use labels with exposed adhesive.

Using card stock

Card stock is heavy, single-ply print media. Many of its variable characteristics, such as moisture content, thickness, and texture, can significantly impact print quality.

Print samples on the card stock being considered for use before buying large quantities.

When printing on card stock:

- From Print Properties, or the control panel, set the Paper type to Light cardstock, Cardstock, or Heavy cardstock.
Note: Use Heavy cardstock for card stock weighing more than 163 g/m².
- Be aware that preprinting, perforation, and creasing may significantly affect the print quality and cause jams or other paper handling problems.
- Check with the manufacturer or vendor to ensure the card stock can withstand temperatures up to 180°C (356° F) without releasing hazardous emissions.
- Do not use preprinted card stock manufactured with chemicals that may contaminate the printer. Preprinting introduces semi-liquid and volatile components into the printer.
- Use grain long card stock when possible.

Storing paper

Use these paper storage guidelines to help avoid jams and uneven print quality:

- For best results, store paper where the temperature is 21°C (70°F) and the relative humidity is 40%. Most label manufacturers recommend printing in a temperature range of 18 to 24°C (65 to 75°F) with relative humidity between 40 and 60%.
- Store paper in cartons when possible, on a pallet or shelf, rather than on the floor.
- Store individual packages on a flat surface.
- Do not store anything on top of individual paper packages.

Supported paper sizes, types, and weights

The following tables provide information on standard and optional paper sources and the types of paper they support.

Note: For an unlisted paper size, select the closest *larger* listed size.

For information on card stock and labels, see the *Card Stock & Label Guide*

Supported paper sizes

Paper size	Dimensions	Standard 250-sheet letter-size tray (Tray 1)	250-sheet legal-size tray (Tray 1)	Optional 530-sheet tray (Tray 2)
A4	210 x 297 mm (8.27 x 11.7 in.)	✓	✓	✓
A5¹	148 x 210 mm (5.83 x 8.27 in.)	✓	✓	X
JIS B5	182 x 257 mm (7.17 x 10.1 in.)	✓	✓	X
Letter	215.9 x 279.4 mm (8.5 x 11 in.)	✓	✓	✓
Legal	215.9 x 355.6 mm (8.5 x 14 in.)	X	✓	X
Executive	184.2 x 266.7 mm (7.25 x 10.5 in.)	✓	✓	✓
Folio	216 x 330 mm (8.5 x 13 in.)	X	✓	X
Statement¹	139.7 x 215.9 mm (5.5 x 8.5 in.)	✓	✓	X
Universal²	250-sheet letter-size tray: 104.8 x 210 mm to 215.9 x 297 mm (4.125 x 8.27 in. to 8.5 x 11.7 in.) ² 250-sheet legal-size tray: 104.8 x 210 mm to 215.9 x 355.6 mm (5.83 x 8.27 in. to 8.5 x 14 in.) ³	✓	✓	X
7 3/4 Envelope (Monarch)	98.4 x 190.5 mm (3.875 x 7.5 in.)	✓	✓	X

¹ Recommended for occasional use only.

² This size setting formats the page or envelope for 215.9 x 297 mm (8.5 x 11.7 in.) for the 250-sheet letter-size tray or 215.9 x 355.6 mm (8.5 x 14 in.) for the 250-sheet legal-size tray based on which tray is installed, unless the size is specified by the software program.

³ Measurements apply to simplex (one-sided) printing only.

Paper size	Dimensions	Standard 250-sheet letter-size tray (Tray 1)	250-sheet legal-size tray (Tray 1)	Optional 530-sheet tray (Tray 2)
Com 10 Envelope	104.8 x 241.3 mm (4.12 x 9.5 in.)	✓	✓	X
DL Envelope	110 x 220 mm (4.33 x 8.66 in.)	✓	✓	X
C5 Envelope	162 x 229 mm (6.38 x 9.01 in.)	✓	✓	X
B5 Envelope	176 x 250 mm (6.93 x 9.84 in.)	✓	✓	X
Other Envelope²	104.8 x 210 mm to 215.9 x 355.6 mm (4.125 x 8.27 in. to 8.5 x 14 in.)	✓	✓	X

¹ Recommended for occasional use only.

² This size setting formats the page or envelope for 215.9 x 297 mm (8.5 x 11.7 in.) for the 250-sheet letter-size tray or 215.9 x 355.6 mm (8.5 x 14 in.) for the 250-sheet legal-size tray based on which tray is installed, unless the size is specified by the software program.

³ Measurements apply to simplex (one-sided) printing only.

Supported paper types

Paper type	Standard 250-sheet letter-size tray (Tray 1)	250-sheet legal-size tray (Tray 1)	Optional 530-sheet tray (Tray 2)
Paper	✓	✓	✓
Card stock	✓	✓	X
Transparencies	✓	✓	X
Paper labels*	✓	✓	X
Envelopes	✓	✓	X
Glossy paper	✓	✓	X

* Vinyl labels are not supported.

Supported paper weights

Paper type	Standard 250-sheet letter-size tray (Tray 1)	250-sheet legal-size tray (Tray 1)	Optional 530-sheet tray (Tray 2)
Plain (xerographic or business) paper	60 to 90 g/m ² grain long (16 to 24 lb bond)	60 to 90 g/m ² grain long (16 to 24 lb bond)	60 to 90 g/m ² grain long (16 to 24 lb bond)
Glossy papers	Book —88 to 176 g/m ² grain long (60 to 120 lb book) Cover —162 to 176 g/m ² grain long (60 to 65 lb cover)	Book —88 to 176 g/m ² grain long (60 to 120 lb book) Cover —162 to 176 g/m ² grain long (60 to 65 lb cover)	X
Card stock—maximum (grain long)¹	Index Bristol —163 g/m ² (90 lb) Tag —163 g/m ² (100 lb) Cover —176 g/m ² (65 lb)	Index Bristol —163 g/m ² (90 lb) Tag —163 g/m ² (100 lb) Cover —176 g/m ² (65 lb)	X
Card stock—maximum (grain short)²	Index Bristol —199 g/m ² (110 lb) Tag —203 g/m ² (125 lb) Cover —216 g/m ² (80 lb)	Index Bristol —199 g/m ² (110 lb) Tag —203 g/m ² (125 lb) Cover —216 g/m ² (80 lb)	X
Transparencies	138–146 g/m ² (37 to 39 lb bond)	138–146 g/m ² (37 to 39 lb bond)	X
Paper Labels—maximum^{2, 3}	180 g/m ² (48 lb bond)	180 g/m ² (48 lb bond)	X
Envelopes⁴	75 to 90 g/m ² (20 to 24 lb bond) ^{5, 6}	75 to 90 g/m ² (20 to 24 lb bond) ^{5, 6}	X

¹ For 60 to 135 g/m² paper, we recommend grain long fibers. For papers heavier than 135 g/m², we recommend grain short.

² The pressure sensitive area must enter the printer first.

³ Vinyl labels are not supported.

⁴ Use sulfite, wood-free, or up to 100% cotton envelopes.

⁵ Maximum weight for 100% cotton envelopes is 90 g/m².

⁶ 105 g/m² (28 lb bond) envelopes must not exceed 25% cotton content.

Paper capacities

Paper type	Standard 250-sheet letter-size tray (Tray 1)	Optional 250-sheet legal-size tray (Tray 1)	Optional 530-sheet tray (Tray 2)
Paper	250 sheets ¹	250 sheets ¹	530 sheets ¹
Card stock	30 sheets ²	30 sheets ²	X

¹ Based on 75 g/m² (20 lb) paper.

² 30 sheets of 163 g/m² (90 lb) card stock or 25 sheets of 199 g/m² (110 lb) card stock.

Paper type	Standard 250-sheet letter-size tray (Tray 1)	Optional 250-sheet legal-size tray (Tray 1)	Optional 530-sheet tray (Tray 2)
Labels	80	80	X
Transparencies	50	50	X
Envelopes	10 of Com 10	10 of Com 10	X
¹ Based on 75 g/m ² (20 lb) paper. ² 30 sheets of 163 g/m ² (90 lb) card stock or 25 sheets of 199 g/m ² (110 lb) card stock.			

Printing

This chapter covers printing, printer reports, and job cancelation. Selection and handling of paper and specialty media can affect how reliably documents print. For more information, see *Avoiding jams* and *Storing print media*.

Installing printer software

A printer driver is software that lets the computer communicate with the printer. The printer software is typically installed during the initial printer setup. For more information, see the *Setup* sheet or *Setup Guide* that shipped with the printer or click **Install printer and software** on the *Software and Documentation CD*.

When **Print** is chosen from a software application, a dialog representing the printer driver opens. Click **Properties**, **Preferences**, **Options**, or **Setup** from the initial Print dialog to open Print Properties and see all of the available printer settings that may be changed. If a feature in Print Properties is unfamiliar, open the online Help for more information.

Note: Print settings selected from the driver override the default settings selected from the control panel.

Printing a document from Windows

- 1 With a document open, click **File → Print**.
- 2 Click **Properties**, **Preferences**, **Options**, or **Setup**.
- 3 Adjust the settings.
- 4 Click **OK**.
- 5 Click **OK** or **Print**.

Printing a document from a Macintosh computer

- 1 With a document open, choose **File → Print**.
- 2 From the Copies & Pages or General pop-up menu, adjust the settings.
- 3 Click **OK** or **Print**.

Printing the configuration page

The configuration page lists information about the printer such as supply levels, printer hardware information, and network information.

- 1 Make sure the printer is on and **Ready** appears.
- 2 From the control panel, press ▲.
- 3 Press ▲ or ▼ repeatedly until **Reports Print** appears, and then press √.
- 4 Press ▲ or ▼ repeatedly until **Configuration Page** appears, and then press √.

After the Configuration Page prints, **Ready** appears.

Printing the demo page

Print the demo page to isolate print quality problems.

- 1 Make sure the printer is on and **Ready** appears.
- 2 From the control panel, press ▲.
- 3 Press ▲ or ▼ repeatedly until **Reports Print** appears, and then press √.
- 4 Press ▲ or ▼ repeatedly until **Demo Page** appears, and then press √.

After the demo page prints, **Ready** appears.

Canceling a print job

There are several methods for canceling a print job. The following sections explain how to cancel a print job from the control panel, or from a computer depending on the operating system.

Canceling a print job from the control panel

To cancel a print job, press  at any time.

Note: If the print job continues to print, part of the job may have already been transmitted to the printer buffer before the stop command was sent. **Cancel Print Job** appears on the display, and the remaining buffered pages are printed before the job is canceled.

Canceling a print job from the Windows taskbar

When you send a job to print, a small printer icon appears in the right corner of the taskbar.

- 1 Double-click the printer icon.
A list of print jobs appears in the printer window.
- 2 Select a job to cancel.
- 3 From the keyboard, press **Delete**.

Canceling a print job from the Windows desktop

- 1 Minimize all programs to reveal the desktop.
- 2 Double-click the **My Computer** icon.
- 3 Double-click the **Printers** icon.
- 4 Double-click the printer icon.
- 5 Select the job to cancel.
- 6 From the keyboard, press **Delete**.

Canceling a print job from Mac OS 9

When you send a job to print, the printer icon for your selected printer appears on the desktop.

- 1 Double-click the printer icon.
A list of print jobs appears in the printer window.
- 2 Choose a job to cancel.

- 3 Click the trash icon.

Canceling a print job from Mac OS X

- 1 Choose **Applications → Utilities**, and then double-click **Print Center** or **Printer Setup Utility**.
- 2 Double-click the printer you are printing to.
- 3 From the printer window, select the job to cancel.
- 4 From the icon bar at the top of the window, click the **Delete** icon.

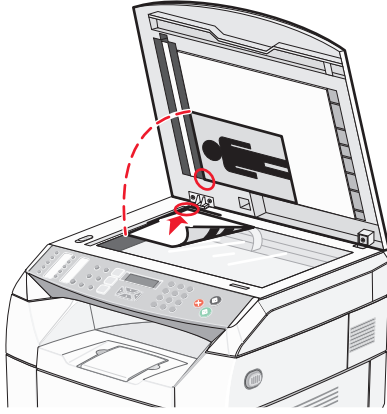

Copying

Automatic Document Feeder (ADF)	Scanner glass
 <p data-bbox="149 766 747 829">Use the Automatic Document Feeder (ADF) for multiple-page A4-, letter-, or legal-size documents.</p>	 <p data-bbox="820 766 1445 856">Use the scanner glass for single pages, small items (such as postcards or photos), transparencies, photo paper, or thin media (such as magazine clippings).</p>

Making a copy

- 1 Load an original document faceup, short edge first into the ADF or facedown on the scanner glass.

Note: Do not load postcards, photos, small items, transparencies, photo paper, or thin media (such as magazine clippings) into the ADF. Place these items on the scanner glass.

- 2 If you are loading a document into the ADF, adjust the paper guides.
- 3 From the control panel, press .
- 4 Use the keypad to enter the number of copies.
- 5 Press  to start copying in black and white, or press  to start copying in color.











Note: To cancel the copy function, press  at any time.

Customizing copy settings

Press  to access copy options while in copy mode.

Selecting a paper tray for copies

To select a paper tray other than the current default tray:

- 1 From the control panel, press .
- 2 Press  or  repeatedly until **Copy Settings** appears, and then press .
- 3 Press  or  repeatedly until **Paper Select** appears, and then press .
- 4 Press  or  repeatedly until the tray you want appears, and then press .
- 5 Press  to return to the **Ready** state.

Selecting a paper size for copies

If you have more than one tray installed, you can load two different sizes of paper. This will allow you to select up to two different paper sizes for copies. To select a paper size other than the current default size (loaded in Tray 1):

- 1 From the control panel, press ▲.
- 2 Press ▲ or ▼ repeatedly until **Copy Settings** appears, and then press √.
- 3 Press ▲ or ▼ repeatedly until **Paper Select** appears, and then press √.
- 4 Press ▲ or ▼ repeatedly until the size you want appears, and then press √.
Note: Only the paper sizes you have loaded in the trays will show up in the menu.
- 5 Press ✖ to return to the **Ready** state.

Reducing or enlarging copies

To change the default size ratio for copies:

















- 1 From the control panel, press ▲.
- 2 Press ▲ or ▼ repeatedly until **Copy Settings** appears, and then press √.
- 3 Press ▲ or ▼ repeatedly until **Reduce/Enlarge** appears, and then press √.
- 4 Press ▲ or ▼ repeatedly until the size ratio you want appears. The size ratios are:
 - 100%
 - 2in1 A4-LTR-LGL
 - 4in1 A4-LTR-LGL
 - 200%
 - 400%
 - Custom 25-400%
 - 25%
 - 50%
 - 78% LGL>LTR
 - 83% LGL>A4
 - 94% A4>LTR
 - 97% LTR>A4
- 5 Press √.
- 6 Press ✖ to return to the **Ready** state.

Note: Copy size can also be temporarily changed by pressing the Reduce / Enlarge button on the control panel. When the printer power is reset, the printer returns to the default settings.

Copying multiple pages onto a single sheet











In order to save paper, you can copy either two or four consecutive pages of a multiple-page document onto a single sheet of paper.

Notes:

- The Paper Size must be set to Letter, Legal, A4, or B5 JIS.
 - The Copy Size must be set to 100%.
 - This feature is available only when making copies using the ADF.
- 1 Load an original document faceup, short edge first into the ADF.
Note: Do not load postcards, photos, small items, transparencies, photo paper, or thin media (such as magazine clippings) into the ADF.
 - 2 Adjust the paper guides.
 - 3 From the control panel, press .
 - 4 Use the keypad to enter the number of copies.
 - 5 Press .
 - 6 Press  or  repeatedly until **Copy Settings** appears, and then press .
 - 7 Press  or  repeatedly until **Reduce/Enlarge** appears, and then press .
 - 8 Press  or  repeatedly until **2in1 A4-LTR-LGL** or **4in1 A4-LTR-LGL** appears, and then press .
 - 9 Press  or  repeatedly to choose the paper orientation, and then press .
 - 10 Press  to return to the **Ready** state.
 - 11 Press  to start copying in black and white, or press  to start copying in color.

Adjusting copy quality





Adjusting the copy quality setting changes the quality of the copies. Choose between Photo (best quality), Text (fastest speed), or Mixed (standard speed). To change the default quality setting:

- 1 From the control panel, press .
- 2 Press  or  repeatedly until **Copy Settings** appears, and then press .
- 3 Press  or  repeatedly until **Quality** appears, and then press .
- 4 Press  or  repeatedly until **Mixed**, **Text**, or **Photo** appears, and then press .
- 5 Press  to return to the **Ready** state.

Note: Copy quality can also be temporarily changed by pressing the Image Quality button on the control panel. When the printer power is reset, the printer returns to the default settings.

Making a copy lighter or darker

Adjusting the density setting makes the copies lighter or darker. To change the default density setting:

- 1 From the control panel, press .
- 2 Press  or  repeatedly until **Copy Settings** appears, and then press .

- 3 Press ▲ or ▼ repeatedly until **Density** appears, and then press √.
- 4 Press ▲ or ▼ repeatedly to adjust the density, and then press √.
- 5 Press ✖ to return to the **Ready** state.

Note: Copy density can also be temporarily changed by pressing the Lighter/Darker button on the control panel. When the printer power is reset, the printer returns to the default settings.

Collating copies

If you print multiple copies of a document, you can choose to print each copy as a set (collated) or to print the copies as groups of pages (not collated).





Collated



Not collated



- 1 Load an original document faceup, short edge first into the ADF or facedown on the scanner glass.

Note: Do not load postcards, photos, small items, transparencies, photo paper, or thin media (such as magazine clippings) into the ADF. Place these items on the scanner glass.
- 2 If you are loading a document into the ADF, adjust the paper guides.
- 3 From the control panel, press .
- 4 Use the keypad to enter the number of copies.
- 5 Press .
- 6 Press ▲ or ▼ repeatedly until **Copy Settings** appears, and then press √.
- 7 Press ▲ or ▼ repeatedly until **Sort** appears, and then press √.
- 8 Press ▲ or ▼ repeatedly until **on** appears, and then press √.
- 9 Press ✖ to return to the **Ready** state.
- 10 Press  to start copying in black and white, or press  to start copying in color.

Canceling a copy job

To cancel a copy job, press ✖ at any time.

Note: If the copy job continues to print, part of the job may have already been transmitted to the printer buffer before the stop command was sent. **Cancel Copy Job** appears on the display, and the remaining buffered pages are printed before the job is canceled.

Scanning

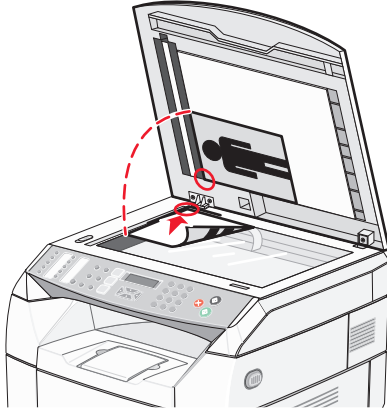
Automatic Document Feeder (ADF)	Scanner glass
 <p data-bbox="151 766 747 829">Use the Automatic Document Feeder (ADF) for multiple-page A4-, letter-, or legal-size documents.</p>	 <p data-bbox="823 766 1445 856">Use the scanner glass for single pages, small items (such as postcards or photos), transparencies, photo paper, or thin media (such as magazine clippings).</p>

Scanning a document using the computer

- 1 Make sure the printer is connected to a computer, and both the printer and the computer are turned on.
- 2 Load an original document faceup into the ADF or facedown on the scanner glass.
Note: Do not load postcards, photos, small items, transparencies, photo paper, or thin media (such as magazine clippings) into the ADF. Place these items on the scanner glass.
- 3 If you are loading a document into the ADF, adjust the paper guides.
- 4 Click **Start** → **Programs** or **All Programs** → **Lexmark Applications** → **Presto! PageManager**.
The Presto! Scan Buttons dialog appears.

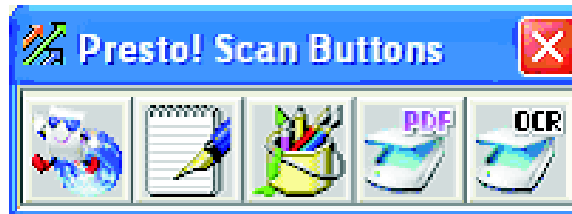

- Note:** If the Presto! Scan Buttons dialog does not appear, press **F9**.
- 5 From the Presto! Scan Buttons toolbar, click the application to scan to.
 - 6 When the scan settings dialog appears, click **Preview**.
Note: If you are using the ADF, the Preview function is not supported. If you are using the scanner glass, you can preview one page at a time.
 - 7 Adjust the scan settings, and then click **Scan**.

Scanning documents directly to other applications

You can scan documents directly to applications that are TWAIN and WIA compliant. For more information, see the application help.

Scanning text for editing

Use the Optical Character Recognition (OCR) software feature to turn scanned images into text you can edit with a word-processing application.

- 1 Make sure:
 - The printer is connected to a computer, and both the printer and the computer are on.
 - ABBYY Fine Reader is installed.
- 2 Load an original document faceup into the ADF or facedown on the scanner glass.
Note: Do not load postcards, photos, small items, transparencies, photo paper, or thin media (such as magazine clippings) into the ADF. Place these items on the scanner glass.
- 3 If you are loading a document into the ADF, adjust the paper guides.
- 4 Click **Start → Programs** or **All Programs → ABBYY FineReader 6.0 Sprint → ABBYY FineReader 6.0 Sprint**.
- 5 From the toolbar, click **Scan&Read**.
- 6 When the scan settings dialog appears, click **Preview**.
Note: If you are using the ADF, the Preview function is not supported. If you are using the scanner glass, you can preview one page at a time.
- 7 For best results, select **Editing Text (OCR)**, and then click **Scan**.
- 8 Once the image loads, click **Save**.
- 9 Select a destination you want to save to, and then click **OK**.
- 10 Edit and save the document.

Customizing scan settings using the computer

- 1 Make sure the printer is connected to a computer, and both the printer and the computer are on.
- 2 Load an original document faceup into the ADF or facedown on the scanner glass.
Note: Do not load postcards, photos, small items, transparencies, photo paper, or thin media (such as magazine clippings) into the ADF. Place these items on the scanner glass.
- 3 If you are loading a document into the ADF, adjust the paper guides.
- 4 Click **Start → Programs** or **All Programs → Lexmark Applications → Presto! PageManager**.
- 5 From the Presto! Scan Buttons toolbar, click the application to scan to.
Note: If the Scan Buttons dialog does not appear, press **F9**.

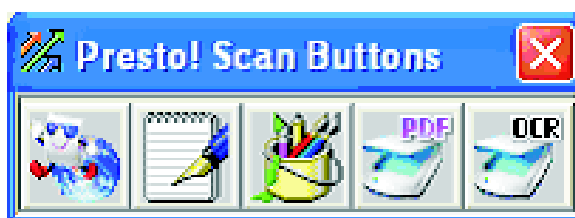

6 Click **Preview**. Wait for the image to appear on the screen.

Note: If you are using the ADF, the Preview function is not supported. If you are using the scanner glass, you can preview one page at a time.

7 If you want to scan only a portion of the document, click and drag the dotted line box to select a specific area of the preview image to scan.

8 Select what document type is being scanned.

9 Customize the scan settings from the General tab or the Advanced tab:

General tab	Options
Scan Page For	<ul style="list-style-type: none"> • Select the scanner IP Address. • Select the scan source (Reflective or Automatic Document Feeder). • Select a preset document type, or choose Custom.
Scan Configuration	<ul style="list-style-type: none"> • Select the mode (True Color, Grayscale, or Black and White). • Select the scan resolution. • Select a preset size, or use the dotted line box in the preview window to select a specific area of the preview image to scan. • Use the Scan task to remove any size adjustments made in the preview window or to select an auto-crop setting.
Note: For more information, click Help at the bottom of the screen.	

Advanced tab	Options
Gamma / Sharpness	<ul style="list-style-type: none"> • Adjust the color correction curve (gamma) of the overall image or of individual color channels. • Select whether to sharpen blurry edges.
Brightness / Contrast	Adjust the brightness of the overall image or of individual color channels.
Saturation / Hue	<ul style="list-style-type: none"> • Adjust the intensity of the colors in the image. • Adjust the hue of the image.
Moire Reduction	Remove image patterns from magazines, newspapers, or art printing (descreen).
Note: For more information, click Help at the bottom of the screen.	

10 Click **Scan**.

Scanning clear images from magazines or newspapers



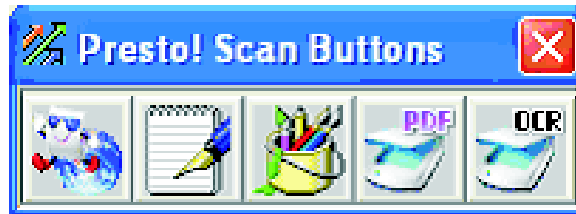

Use the Moire Reduction feature to help remove wavy patterns from images scanned from magazines or newspapers.

- 1 Make sure the printer is connected to a computer, and both the printer and the computer are turned on.
- 2 Load an original document faceup into the ADF or facedown on the scanner glass.
Note: Do not load postcards, photos, small items, transparencies, photo paper, or thin media (such as magazine clippings) into the ADF. Place these items on the scanner glass.
- 3 If you are loading a document into the ADF, adjust the paper guides.
- 4 Click **Start** → **Programs** or **All Programs** → **Lexmark Applications** → **Presto! PageManager**.
The Presto! Scan Buttons dialog appears.



- Note:** If the Presto! Scan Buttons dialog does not appear, press **F9**.
- 5 From the Presto! Scan Buttons toolbar, click the application to scan to.
- 6 When the scan settings dialog appears, click **Preview**.
Note: If you are using the ADF, the Preview function is not supported. If you are using the scanner glass, you can preview one page at a time.
- 7 Click the **Advanced** tab.
- 8 Select **Moire Reduction**.
- 9 Choose either **Magazine**, **Newspaper**, or **Art Print**, and then click **Scan**.

Scanning to a computer over the network

- 1 Make sure the printer is connected to the network through a print server, and the printer, the print server, and the computer receiving the scan are all turned on.
- 2 Load an original document faceup into the ADF or facedown on the scanner glass.
Note: Do not load postcards, photos, small items, transparencies, photo paper, or thin media (such as magazine clippings) into the ADF. Place these items on the scanner glass.
- 3 If you are loading a document into the ADF, adjust the paper guides.
- 4 From the control panel, press .
- 5 Use the quick access panel to choose a scan destination (1–20), or press the **Directory** button to search for a stored name.
- 6 Press  to start scanning in black and white, or press  to start scanning in color.
Note: To cancel the scan function, press  at any time.

Setting up the scan directory

- 1 Open a Web browser.
- 2 In the address bar, type the IP address of the printer, and then press **Enter**.
If the Java applet screen appears, click **Yes**.
- 3 Click **Scan Destination**.
- 4 Under New Destination, from the drop-down menu, select **Email,FTP**, or **PC**.
- 5 Enter your scan settings, and then click **Submit**.

Note: If authorization is required, enter the administrator password before clicking **Submit**.

Searching the scan directory

- 1 From the control panel, press .
- 2 Press the **Directory** button.
- 3 Use the keypad to type the name you are searching for, and then press \checkmark .

Notes:

- If you know the One Touch Button (1–20) assigned to the name, you can directly select the name using the quick access panel.
- To return to **Ready**, press  at any time.

Canceling a scan job



To cancel a scan job, press  at any time.

Customizing scan settings from the control panel

Press \blacktriangle to access scan settings while in scan mode.

Changing the Document Size setting

The Document Size setting defines the size of the original document being scanned.

- 1 From the control panel, press .
- 2 Press \blacktriangle or \blacktriangledown repeatedly until **Scan Settings** appears, and then press \checkmark .
- 3 Press \blacktriangle or \blacktriangledown repeatedly until **Document Size** appears, and then press \checkmark .
- 4 Press \blacktriangle or \blacktriangledown repeatedly until the correct size appears, and then press \checkmark .
- 5 Press  to return to the **Ready** state.

Adjusting the scan resolution

- 1 From the control panel, press .
- 2 Press \blacktriangle or \blacktriangledown repeatedly until **Scan Settings** appears, and then press \checkmark .
- 3 Press \blacktriangle or \blacktriangledown repeatedly until **Resolution** appears, and then press \checkmark .

- 4 Press ▲ or ▼ repeatedly until the resolution you want appears, and then press √.
- 5 Press ✖ to return to the **Ready** state.

Note: Scan resolution can also be temporarily changed by pressing the Image Quality button on the control panel. When the printer power is reset, the printer returns to the default settings.

Making a scanned image lighter or darker

Adjusting the density setting makes scanned images lighter or darker. To change the default density setting:

- 1 From the control panel, press ↶.
- 2 Press ▲ or ▼ repeatedly until **Scan Settings** appears, and then press √.
- 3 Press ▲ or ▼ repeatedly until **Density** appears, and then press √.
- 4 Press ▲ or ▼ repeatedly to adjust the density, and then press √.
- 5 Press ✖ to return to the **Ready** state.

Note: Scan density can also be temporarily changed by pressing the Lighter/Darker button on the control panel. When the printer power is reset, the printer returns to the default settings.

Faxing

Notes:

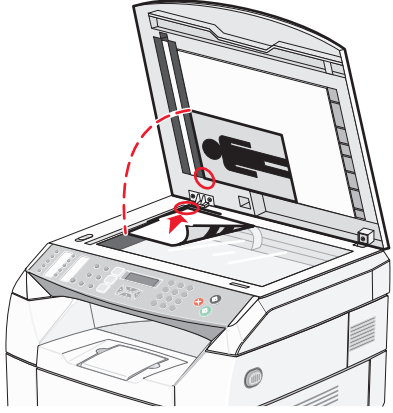

- The Fax function is not available on all models.
- Color faxing is not supported. Press  to start a black and white fax job.

Automatic Document Feeder (ADF)	Scanner glass
 <p data-bbox="149 919 747 982">Use the Automatic Document Feeder (ADF) for multiple-page A4-, letter-, or legal-size documents.</p>	 <p data-bbox="820 919 1445 1014">Use the scanner glass for single pages, small items (such as postcards or photos), transparencies, photo paper, or thin media (such as magazine clippings).</p>

Sending a fax



Note: New Zealand telecom users: If a charge for local calls is unacceptable, *do not* use the “Dial” button for local calls. Only the seven digits of the local number should be dialed from your telephone. *Do not* dial the area code digit or the “0” prefix.

Sending a fax using the ADF

- 1 Make sure the printer is on and is connected to a working phone line.
- 2 Load an original document faceup, short edge first into the ADF.
Note: Do not load postcards, photos, small items, transparencies, photo paper, or thin media (such as magazine clippings) into the ADF. Place these items on the scanner glass.
- 3 Adjust the paper guides.
- 4 From the control panel, press .
- 5 Enter a fax number using Quick Dial, Speed Dial, or manual dialing.
- 6 Press  to start the fax job.

Note: If the memory is full, the document is sent in real time.



Sending a fax using the scanner glass

- 1 Make sure the printer is on and is connected to a working phone line.
- 2 Place the first page facedown on the scanner glass.
- 3 From the control panel, press .
- 4 Enter a fax number using Quick Dial, Speed Dial, or manual dialing.
- 5 Press  to start the fax job.
After the page is scanned, **NEXT PAGE? 1. YES 2. NO** appears.
- 6 If you want to send a single page, press **2** to start the fax job.
- 7 If you want to send more than one page, press **1** to scan the next page. Place the next page on the scanner glass, and then press .
- 8 Repeat step 7 for all necessary pages, and then press **2** to start the fax job.

Note: If the memory is full, the document is sent in real time.



Sending a broadcast fax

You can send the same fax to more than one fax number. You can include Quick Dial numbers, Speed Dial numbers, and up to 50 manually dialed numbers in the same broadcast.

- 1 Make sure the printer is on and is connected to a working phone line.
- 2 Load an original document faceup, short edge first into the ADF or facedown on the scanner glass.
Note: Do not load postcards, photos, small items, transparencies, photo paper, or thin media (such as magazine clippings) into the ADF. Place these items on the scanner glass.
- 3 If you are loading a document into the ADF, adjust the paper guides.
- 4 From the control panel, press .
- 5 Enter a fax number using Quick Dial, Speed Dial, or manual dialing.
- 6 Press  after each number.
- 7 Press  to start the fax job.



The pages are automatically scanned and sent in the order in which they were loaded.

Canceling a broadcast fax

- 1 From the control panel, press .
- The name or the fax number being dialed appears.
- 2 Press .
- 3 Press **1**.
- 4 Press  to cancel the fax.



Sending a fax while listening to a call (On Hook Dial)

The manual dialing feature lets you dial a fax number while listening to the call through a speaker on the printer. It is useful when you must navigate an automated answering system or enter a calling card number before sending a fax.

- 1 Make sure the printer is on and is connected to a working phone line.
- 2 Load an original document faceup, short edge first into the ADF or facedown on the scanner glass.
Note: Do not load postcards, photos, small items, transparencies, photo paper, or thin media (such as magazine clippings) into the ADF. Place these items on the scanner glass.
- 3 If you are loading a document into the ADF, adjust the paper guides.
- 4 From the control panel, press .
- 5 Pick up the handset of the external telephone and listen for a dial tone, or press **Hook** and listen for a dial tone.
- 6 On the external telephone, dial the fax number you want to call. If you pressed Hook, dial the number using the keypad.
- 7 When you hear a fax tone, press .
- 8 If you picked up the handset of an external telephone, replace it.

Sending a fax at the end of a conversation

At the end of a telephone conversation, you can send a fax to the other party before you both hang up.

- 1 Make sure the printer is on and is connected to a working phone line.
- 2 Load an original document faceup, short edge first into the ADF or facedown on the scanner glass.
Note: Do not load postcards, photos, small items, transparencies, photo paper, or thin media (such as magazine clippings) into the ADF. Place these items on the scanner glass.
- 3 If you are loading a document into the ADF, adjust the paper guides.
- 4 Ask the other party to wait for fax tones, and then to press their start or send button before hanging up.
- 5 From the control panel, press .
- 6 Press .
- 7 If you placed the document on the scanner glass, press **1** to send the fax.
- 8 Replace the external telephone handset.

Canceling a fax job

Press  at any time if you want to cancel a fax while the printer is scanning, dialing, or sending the fax.

Receiving a fax

Understanding the fax receive modes

Fax receive mode	Description
Fax Only	The printer automatically answers every call as a fax. Use this mode: <ul style="list-style-type: none">• For dedicated fax lines• When no external or extension telephone is attached
Fax Tad	An external answering device (TAD) is connected. The TAD automatically answers every call. Voice messages are stored on the external TAD. If it is a fax call, the printer receives the fax. Use this mode when an answering machine is connected to the EXT port  of the printer. Notes: <ul style="list-style-type: none">• The external TAD setting works only with an external answering machine.• The printer needs to have the answer ring set to larger than the TAD, and the TAD needs to be 4 or less.
Manual	You control the phone line and must answer every call yourself unless you are using the Distinctive ring feature. Use this mode if: <ul style="list-style-type: none">• You have very few fax messages.• Distinctive ring is being used or a computer is being used on the same line. Note: If you answer the telephone and hear fax tones, wait until the printer takes over the call, and then hang up.

Setting the fax receive mode

- 1 From the control panel, press ▲.
- 2 Press ▲ or ▼ repeatedly until **Fax Settings** appears, and then press √.
- 3 Press ▲ or ▼ repeatedly until **RX Settings** appears, and then press √.
- 4 Press ▲ or ▼ repeatedly until **RX Mode** appears, and then press √.
- 5 Press ▲ or ▼ repeatedly until the fax receive mode you want appears, and then press √.
- 6 Press ✖ to return to the **Ready** state.

Receiving a fax at the end of a conversation

At the end of a telephone conversation, you can ask the other party to fax you information before you both hang up.

- 1 Before hanging up, ask the other party to press their start or send button.
- 2 When you hear the fax tones of their fax machine, press .
- 3 Press 2 to receive the fax.
- 4 Replace the external telephone handset.

Receiving a fax from an extension telephone

If you answer a fax call on an extension telephone or an external telephone connected to the EXT port  of the printer, you can make the printer take the call by using the Fax receive code. When you press the Fax receive code (51), the printer starts to receive the fax. Press **51** and wait for the beep or until **Receiving** appears on the display, and then hang up.

Adjusting fax activity report settings

The printer can be set to print an activity report automatically every 100 faxes (Auto Print), or manually after every fax (Not Printed). You can print reports of faxes sent and/or received.

- 1 From the control panel, press ▲.
- 2 Press ▲ or ▼ repeatedly until **Fax Settings** appears, and then press √.
- 3 Press ▲ or ▼ repeatedly until **Report Settings** appears, and then press √.
- 4 Press ▲ or ▼ repeatedly until **Activity Report** appears, and then press √.
- 5 Press ▲ or ▼ repeatedly until **Auto Print** or **Not Printed** appears, and then press √.
- 6 Press ❌ to return to the **Ready** state.

Printing fax activity reports

You can print reports of faxes sent and/or received.

- 1 From the control panel, press ▲.
- 2 Press ▲ or ▼ repeatedly until **Reports Print** appears, and then press √.
- 3 Press ▲ or ▼ repeatedly until **Activity Report** appears, and then press √.

After the Activity Report prints, **Ready** appears.

Setting up Quick Dial numbers

There are 20 Quick Dial numbers where fax numbers for automatic dialing can be stored. To access Quick Dial numbers 1–10, press the Quick Dial button (1–10) that corresponds to the number you want to access. To access numbers 11–20, press the **Shift** button, and then press the Quick Dial button that corresponds to the number you want to access. To set up Quick Dial numbers:

- 1 From the control panel, press ▲.
- 2 Press ▲ or ▼ repeatedly until **Fax Directory** appears, and then press √.
- 3 Press ▲ or ▼ repeatedly until **Quick Dial Entry** appears, and then press √.
- 4 Press ▲ or ▼ repeatedly to choose a Quick Dial number (1–20), or use the keypad to directly enter the number, and then press √.
- 5 Press ▲ or ▼ repeatedly until **Fax # Entry** appears, and then press √.
- 6 Use the keypad to enter the fax number, and then press √.
- 7 Press ▲ or ▼ repeatedly until **Fax Name Entry** appears, and then press √.

- 8 Use the keypad to type the name, and then press \checkmark .
- 9 Press \times to return to the **Ready** state.

Note: You can edit or replace an existing Quick Dial name or number by following the same steps.

Printing the Quick Dial list

- 1 From the control panel, press \blacktriangle .
 - 2 Press \blacktriangle or \blacktriangledown repeatedly until **Reports Print** appears, and then press \checkmark .
 - 3 Press \blacktriangle or \blacktriangledown repeatedly until **Quick Dial List** appears, and then press \checkmark .
- After the Quick Dial list prints, **Ready** appears.

Setting up Speed Dial numbers

There are 50 Speed Dial numbers where fax numbers for automatic dialing can be stored. To access Speed Dial numbers, press the **Directory** button followed by the Speed Dial entry (1–50).

- 1 From the control panel, press \blacktriangle .
- 2 Press \blacktriangle or \blacktriangledown repeatedly until **Fax Directory** appears, and then press \checkmark .
- 3 Press \blacktriangle or \blacktriangledown repeatedly until **Speed Dial Entry** appears, and then press \checkmark .
- 4 Press \blacktriangle or \blacktriangledown repeatedly to choose the Speed Dial number (1–50), or use the keypad to directly enter the number, and then press \checkmark .
- 5 Press \blacktriangle or \blacktriangledown repeatedly until **Fax # Entry** appears, and then press \checkmark .
- 6 Use the keypad to enter the fax number, and then press \checkmark .
- 7 Press \blacktriangle or \blacktriangledown repeatedly until **Fax Name Entry** appears, and then press \checkmark .
- 8 Use the keypad to type the name, and then press \checkmark .
- 9 Press \times to return to the **Ready** state.

Note: You can edit or replace an existing Speed Dial name or number by following the same steps.

Printing the Speed Dial list

Items in the Speed Dial list are printed in the order you specify. Choose to sort by Speed Dial number (No Sort) or to sort alphabetically by Speed Dial name (Sort By Name).

- 1 From the control panel, press \blacktriangle .
 - 2 Press \blacktriangle or \blacktriangledown repeatedly until **Reports Print** appears, and then press \checkmark .
 - 3 Press \blacktriangle or \blacktriangledown repeatedly until **Speed Dial List** appears, and then press \checkmark .
 - 4 Press \blacktriangle or \blacktriangledown repeatedly until **No Sort** or **Sort By Name** appears, and then press \checkmark .
- After the Speed Dial list prints, **Ready** appears.











Understanding the dialing options

Dialing option	Description
Manual dialing	Manually type the fax number using the keypad.
Quick dialing	Press the Quick Dial button that stores the number you want to call. Note: To dial Quick Dial numbers 11–20, press the Shift button, and then press the Quick Dial button that corresponds to the number you want to dial.
Speed dialing	Press the Directory button, followed by a Speed Dial number. Note: If Not Registered # appears when you enter the Speed Dial number, then a number has not been stored at this location.
Redial	If you are sending a fax manually and the line is busy, press Redial / Pause , and then press  to try again. Note: If you are sending a fax automatically and the line is busy, the printer will automatically redial one time after five minutes.

Customizing dial settings

Setting the dialing mode

Depending on the type of phone line being used, the printer can be set to Touch Tone or Pulse dialing. The factory default setting is Touch Tone.

- 1 From the control panel, press .
- 2 Press  or  repeatedly until **Admin Settings** appears, and then press .
- 3 Press  or  repeatedly until **TEL Line Type** appears, and then press .
- 4 Press  or  repeatedly until the dialing mode you want appears, and then press .
- 5 Press  to return to the **Ready** state.

Adjusting the volume

The volume can be adjusted for the keypad, telephone ring, line monitor, end tone, and alarm.

Volume setting	Description
Keypad Volume	Sets the volume of the beep that sounds when a key is pressed.
Ring Volume	Sets the ring volume.
Line Mon. Vol	Sets the dialing and on-hook volume.
Job End Tone Vol	Sets whether the printer sounds a one-second end tone.
Job Error Tone Vol	Sets whether the printer sounds a four-second end tone.
Alarm Volume	Sets the alarm volume.

To set the volume for any of the above settings:

- 1 From the control panel, press ▲.
- 2 Press ▲ or ▼ repeatedly until **Machine Settings** appears, and then press √.
- 3 Press ▲ or ▼ repeatedly until **Speaker Volume** appears, and then press √.
- 4 Press ▲ or ▼ repeatedly until the volume setting you want appears, and then press √.
- 5 Press ▲ or ▼ repeatedly until the volume level you want appears, and then press √.

Note: Volume levels range from 0–3, with 0 being silent and 3 being the loudest volume. The factory default setting is 0.

- 6 Press ✖ to return to the **Ready** state.

Setting the number of rings before receiving a fax automatically

The Ring Count Delay sets the number of times the phone line rings before the printer answers in Fax Only mode. If you have extension phones on the same line as the printer, or subscribe to the telephone company's Distinctive Ring service, keep the Ring Count Delay setting at 4.

- 1 From the control panel, press ▲.
- 2 Press ▲ or ▼ repeatedly until **Fax Settings** appears, and then press √.
- 3 Press ▲ or ▼ repeatedly until **RX Settings** appears, and then press √.
- 4 Press ▲ or ▼ repeatedly until **Ring Count Delay** appears, and then press √.
- 5 Press ▲ or ▼ repeatedly to set how many times the phone line rings before the printer answers (0–99), and then press √.
- 6 Press ✖ to return to the **Ready** state.

When the number of rings you set is detected, the printer automatically receives the incoming fax. Set the Ring Count Delay to 0 to disable the line from ringing.

Setting up to fax while behind a PBX

If the printer is being used in a business or office, it may be connected to a Private Branch Exchange (PBX) telephone system. Ordinarily, when dialing a fax number, the printer waits to recognize the dial tone and then dials the fax number. However, this method of dialing may not work if the PBX telephone system uses a dial tone that is not recognizable to most fax machines. PBX Selection enables the printer to dial the fax number without waiting to recognize the dial tone.

- 1 From the control panel, press ▲.
- 2 Press ▲ or ▼ repeatedly until **Admin Settings** appears, and then press √.
- 3 Press ▲ or ▼ repeatedly until **PBX Selection** appears, and then press √.
- 4 Press ▲ or ▼ repeatedly until the type of PBX connection you want appears, and then press √.
- 5 Press ↶ to exit the PBX selection menu.
- 6 Press ▲ or ▼ repeatedly until **PBX Access Digit** appears, and then press √.

- 7 Press ▲ or ▼ repeatedly until the PBX access number (1–999) you want appears, and then press ✓.
- 8 Press ✖ to return to the **Ready** state.

Customizing fax settings

Making a fax lighter or darker

If the original document is very light or very dark, you may want to change the contrast.

- 1 Make sure the printer is on and is connected to a working phone line.
- 2 Load an original document faceup, short edge first into the ADF or facedown on the scanner glass.
Note: Do not load postcards, photos, small items, transparencies, photo paper, or thin media (such as magazine clippings) into the ADF. Place these items on the scanner glass.
- 3 If you are loading a document into the ADF, adjust the paper guides.
- 4 From the control panel, press .
- 5 Press ▲.
- 6 Press ▲ or ▼ repeatedly until **Fax Settings** appears, and then press ✓.
- 7 Press ▲ or ▼ repeatedly until **TX Settings** appears, and then press ✓.
- 8 Press ▲ or ▼ repeatedly until **Density** appears, and then press ✓.
- 9 Press ▲ or ▼ to adjust the contrast, and then press ✓.
- 10 Press ✖ to return to the **Ready** state and fax as normal.

Changing the fax resolution

Adjusting the resolution setting changes the quality of the fax. Choose between Standard (fastest speed), Photo (slowest speed, best image quality), or Fine (slower speed, higher detail). To change the default resolution setting:

- 1 Make sure the printer is on and is connected to a working phone line.
- 2 Load an original document faceup, short edge first into the ADF or facedown on the scanner glass.
Note: Do not load postcards, photos, small items, transparencies, photo paper, or thin media (such as magazine clippings) into the ADF. Place these items on the scanner glass.
- 3 If you are loading a document into the ADF, adjust the paper guides.
- 4 From the control panel, press .
- 5 Press ▲.
- 6 Press ▲ or ▼ repeatedly until **Fax Settings** appears, and then press ✓.
- 7 Press ▲ or ▼ repeatedly until **TX Settings** appears, and then press ✓.
- 8 Press ▲ or ▼ repeatedly until **Resolution** appears, and then press ✓.
- 9 Press ▲ or ▼ repeatedly to adjust the resolution, and then press ✓.
- 10 Press ✖ to return to the **Ready** state.

Setting up real time fax transmission

When you are sending a fax, the printer ordinarily scans the documents into the memory before sending them. As soon as the phone line is free, the printer starts dialing and sending. However, if the memory is full, the printer sends the document immediately. Occasionally, you may want to send a document immediately, without waiting for memory transmission. You can set real time transmission to On for all faxes, or to Next Fax Only for the current fax.

- 1 From the control panel, press .
- 2 Press **▲**.
- 3 Press **▲** or **▼** repeatedly until **Fax Settings** appears, and then press **√**.
- 4 Press **▲** or **▼** until **TX Settings** appears, and then press **√**.
- 5 Press **▲** or **▼** repeatedly until **Immediate TX** appears, and then press **√**.
- 6 Press **▲** or **▼** repeatedly until **On** or **Next Fax Only** appears, and then press **√**.
- 7 Press **⊗** to return to the **Ready** state.

Selecting a paper tray for incoming faxes

The factory default setting of Auto lets the printer choose the paper from Tray 2 if Tray 1 is out of paper or if incoming faxes will fit best on the paper in Tray 2.

To change the paper tray setting:

- 1 From the control panel, press **▲**.
- 2 Press **▲** or **▼** repeatedly until **Fax Settings** appears, and then press **√**.
- 3 Press **▲** or **▼** repeatedly until **Tray Settings** appears, and then press **√**.
- 4 Press **▲** or **▼** repeatedly until **Tray Use: Fax** appears, and then press **√**.
- 5 Press **▲** or **▼** repeatedly until the tray option you want appears, and then press **√**.
- 6 Press **⊗** to return to the **Ready** state.

Reducing the print size of an incoming fax

Auto Reduction enables the printer to automatically reduce an incoming fax to fit on one page of letter-, legal-, or A4-size paper. The reduction ratio is calculated by using the page size of the fax and the size of the paper in the tray.

- 1 From the control panel, press **▲**.
- 2 Press **▲** or **▼** repeatedly until **Fax Settings** appears, and then press **√**.
- 3 Press **▲** or **▼** repeatedly until **RX Settings** appears, and then press **√**.
- 4 Press **▲** or **▼** repeatedly until **Auto Reduction** appears, and then press **√**.
- 5 Press **▲** or **▼** to turn Auto Reduction **On** or **Off**, and then press **√**.
- 6 Press **⊗** to return to the **Ready** state.

Clearing jams

Avoiding jams

The following hints can help you avoid jams:

- Use only recommended paper or specialty media.

For more information, see the *Card Stock & Label Guide* available on the Lexmark Web site at www.lexmark.com/publications.

- Do not load too much paper. Make sure the stack height does not exceed the indicated maximum height.
- Do not load wrinkled, creased, damp, or curled paper.
- Flex, fan, and straighten paper before loading it.
- Do not use paper that has been cut or trimmed by hand.
- Do not mix paper sizes, weights, or types in the same stack.
- Store the paper in an appropriate environment.
- Do not remove trays while the printer is printing.
- Push all trays in firmly after loading paper.
- Make sure the guides in the trays are properly positioned, and are not pressing too tightly against the paper.
- Make sure all printer cables are attached correctly. For more information, see the setup documentation.

Understanding jam messages and locations

Open doors and covers, and remove trays to access jam locations. The illustration shows possible jam locations. To resolve any jam message, you must clear all paper from the paper path.

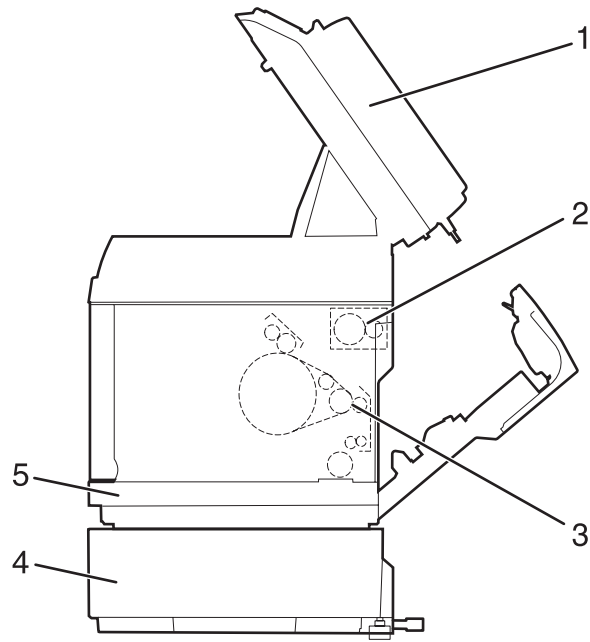

	Jam message	Area name
1	ADF Jam Open ADF Cover and Clear Jam	ADF door
2	Paper Jam C Open Rear Cover and Clear Jam	Rear door (top)
3	Paper Jam B Open Rear Cover and Clear Jam	Rear door (bottom)
4	Paper Jam A2 Remove Tray2 and Clear Jam	Optional 530-sheet tray (Tray 2)
5	Paper Jam A1 Remove Tray1 and Clear Jam	Standard tray (Tray 1)

Clearing Tray 1 jams

If the paper did not feed from Tray 1 correctly, the jam is in the tray. **Paper Jam A1: Remove Tray1 and Clear Jam** appears. Tray 1 could be the 250-sheet letter-size tray or the 250-sheet legal-size tray.

- 1 Pull Tray 1 out. Remove the tray completely.

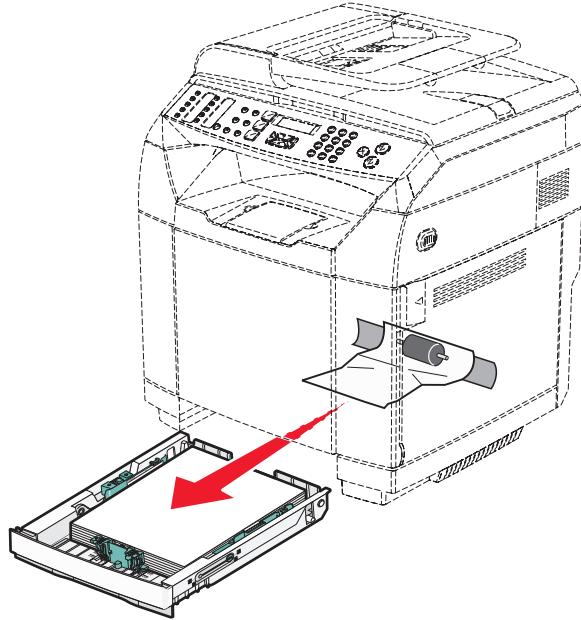

- 2 Remove the jam. The jam could be in the tray or behind the tray area.

- **Jams in the tray**—Locate the single piece of paper lying on top of the stack. Pull it straight out.

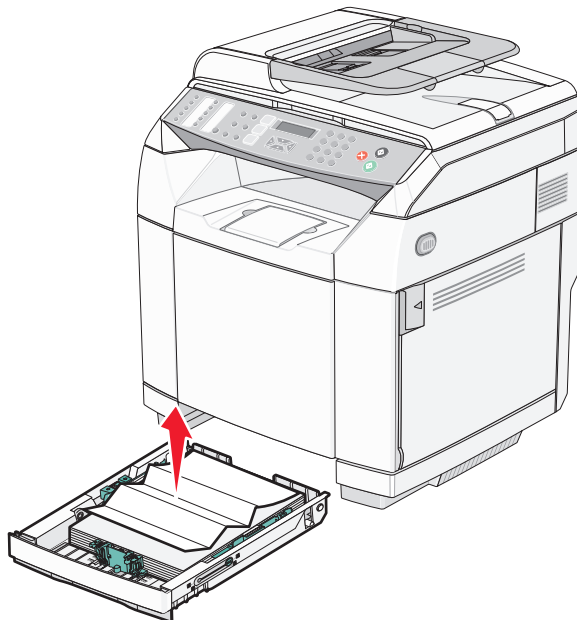

- **Jams behind the tray area**—Locate the jam on the bottom surface of the tray housing. You may have to reach far under the printer to locate the jam, as shown in the following illustration. Pull the jam straight out.

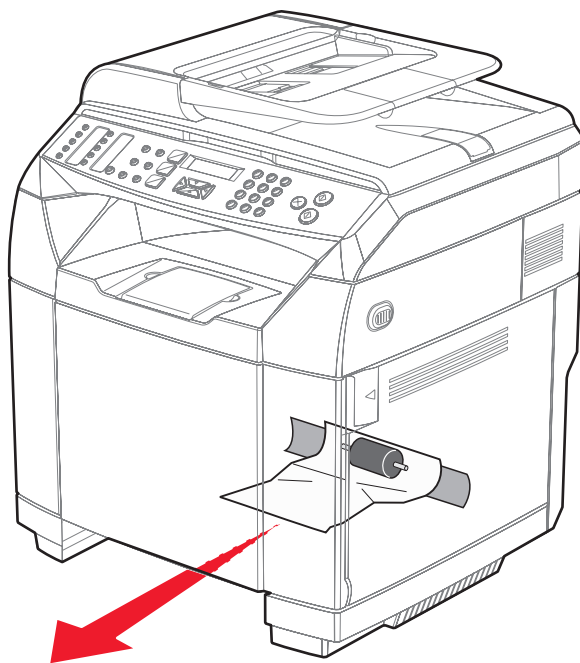

3 Insert the tray.

Clearing Tray 2 jams

If the paper did not feed from Tray 2 correctly, the jam is in the tray. **Paper Jam A2: Remove Tray2 and Clear Jam** appears.

- 1 Pull Tray 2 out. Remove the tray completely.
- 2 Remove the jam. The jam could be in the tray or behind the tray area.
 - **Jams in the tray**—Locate the single piece of paper lying on top of the stack. Pull it straight out.

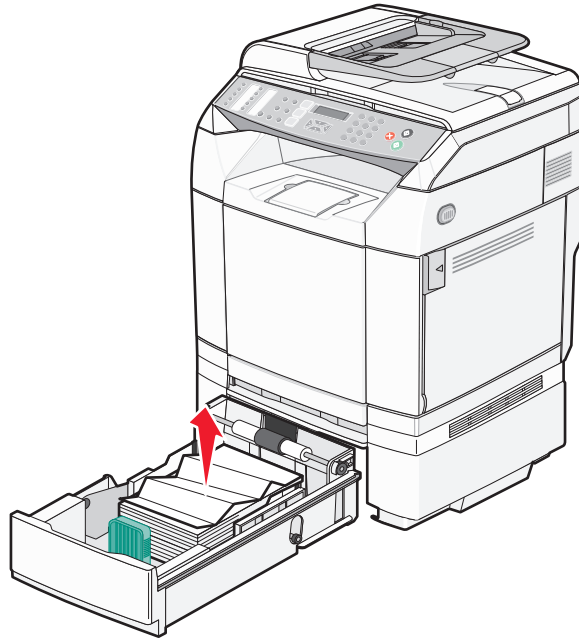

- **Jams behind the tray area**—Locate the jam on the bottom surface of the tray housing. You may have to reach far under the printer to locate the jam, as shown in the following illustration. Pull the jam straight out.

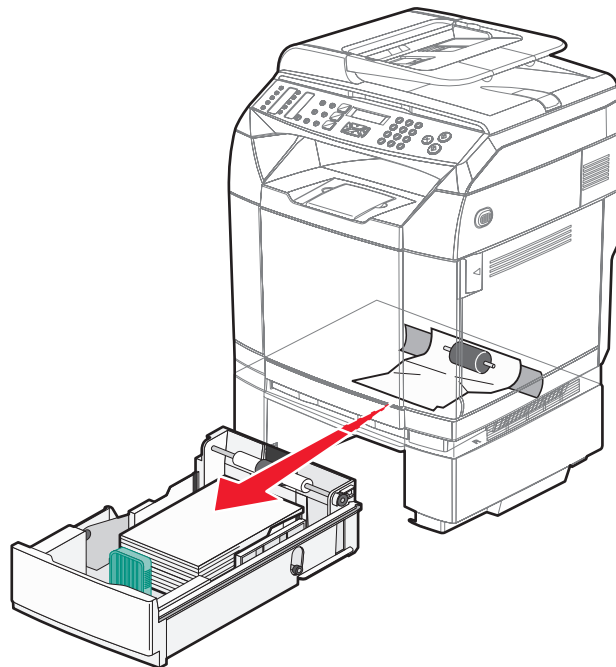

- 3 Insert the tray.

Clearing jams behind the rear door

If the paper is jammed behind the rear door, **Paper Jam <x>** appears. The affected area is indicated by the **Jam <x>** message. A **Paper Jam B** message indicates the paper is jammed behind the rear door below the fuser. A **Paper Jam C** message indicates the paper is jammed behind the rear door above the fuser.



CAUTION: To reduce the risk of injury from a hot component, allow the surface to cool before touching it.

- 1 Push the rear door release latch.

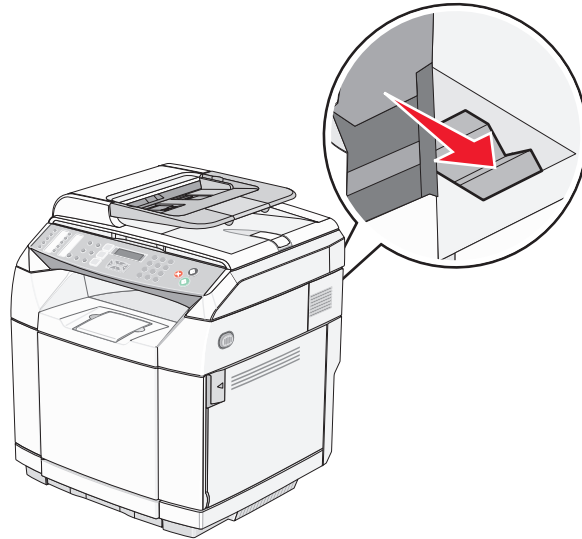

- 2 Gently lower the rear door.

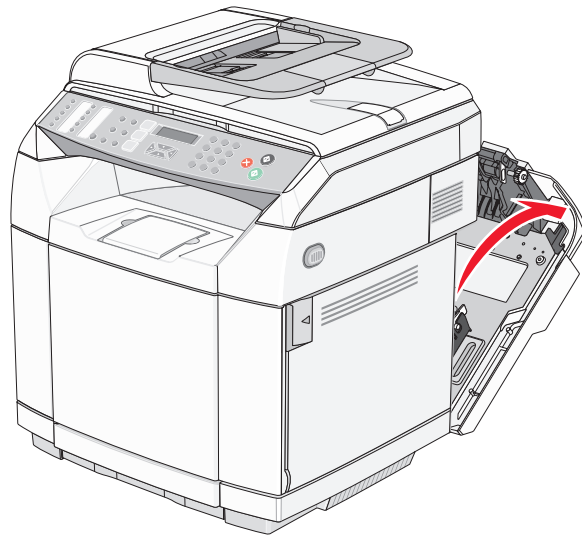

- 3 Pull the fuser pressure release levers to release tension on the paper.

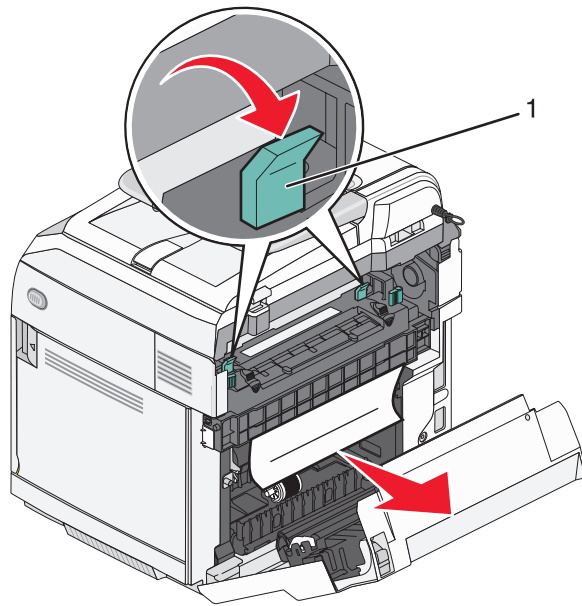

1 Pressure release levers

4 Grasp each side of the jammed paper.

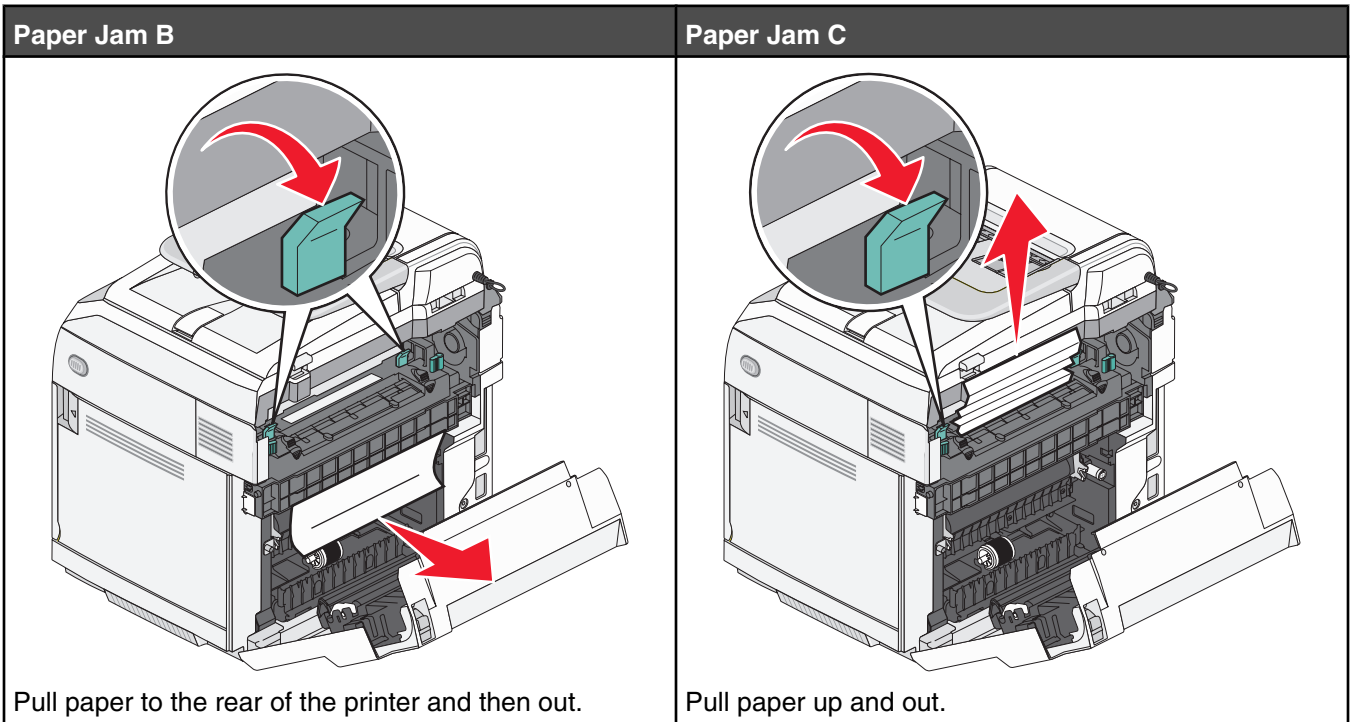

Note: Gently pull the paper out to avoid tearing it. Whenever possible, pull the paper towards the bottom of the printer to avoid contaminating the fuser.

5 Close the rear door.

Paper jam in the ADF

If the paper is jammed in the ADF, **ADF Jam: Open ADF Cover and Clear Jam** appears.

Warning: Do not pull the jammed paper out until you lift the tension release lever that raises the pick roller assembly.

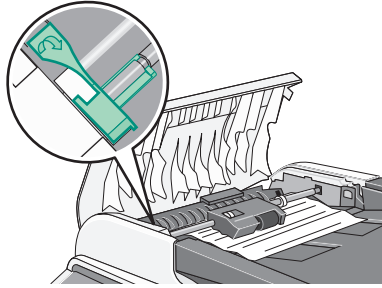

Warning: Do not pull the jammed paper out from the bottom of the ADF.



1 Open the ADF cover.

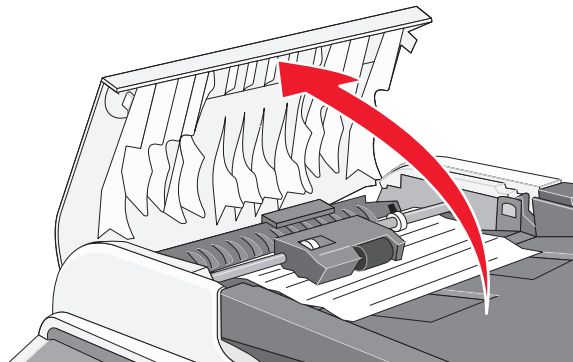

2 Lift the tension release lever so that it is in the up position.

Note: Do not completely remove the pick roller assembly. Doing so repeatedly may cause damage to the ADF.

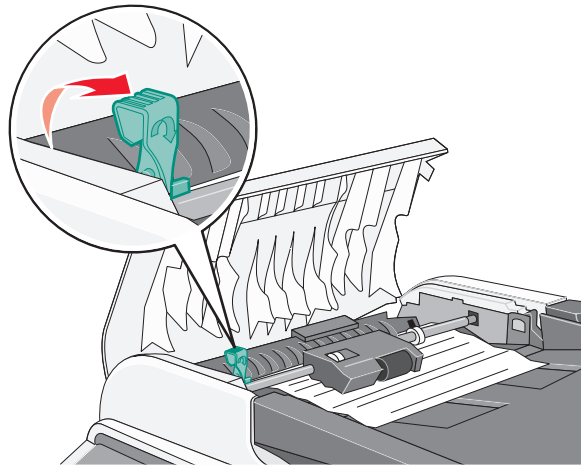

3 Firmly grasp the paper, and gently pull it out.

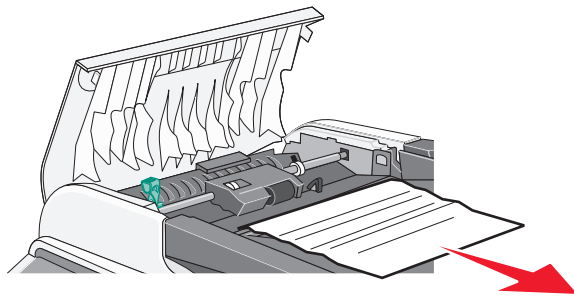

4 Lower the tension release lever back into place until it locks.

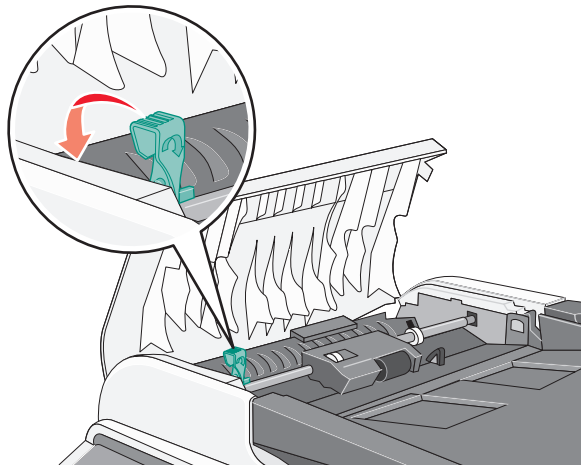

5 Close the ADF cover.

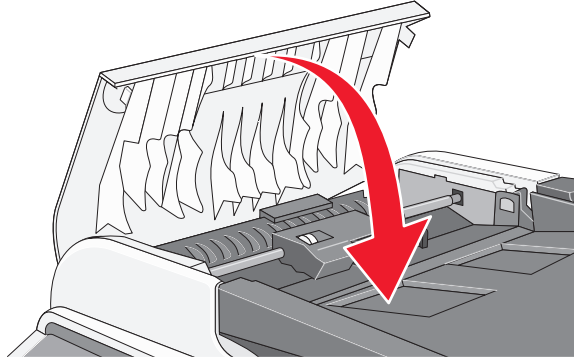

6 Press ✓.

Understanding printer menus

Menus list

A number of menus are available to make it easy for you to change printer settings:

Copy Settings	Machine Settings	Network Settings	Reports Print
Paper Select	Speaker Volume	Ethernet	Configuration Page
Sort	Paper Settings	IP Configuration	Activity Report
Quality	Job Timeout		Memory List
Density	Toner Saver Mode		Quick Dial List
Reduce/Enlarge	Supplies Info		Speed Dial List
	Scanner Carriage		Scan Directory
			Scan Transmission Log
			Demo Page
			Maintenance Page
Scan Settings	Fax Settings	Fax Directory	Admin Settings
Document Size	TX Settings	Quick Dial Entry	Date/Time Setup
Multi Page in A Document	RX Settings	Speed Dial Entry	User Settings
Limitless Scan	Tray Settings		TEL Line Type
Color Compressed Ratio	Delete Document		PBX Selection
Resolution	Comm Settings		PBX Access Digit
Density	Report Settings		Default Mode
Limitation Of Size Of Mail			Auto Clear
			Power Saver
			Display Language
			Country Code
			Setting Default
			Admin Menu Lock

Copy Settings menu

Menu item	Description
Paper Select Auto Tray1 Tray2	Sets the paper source for copies Notes: <ul style="list-style-type: none"> • Auto is the factory default setting. • Tray2 appears only if Tray 2 is installed.

Menu item	Description
Sort Off On	Stacks the pages of a print job in sequence when printing multiple copies Notes: <ul style="list-style-type: none"> • Off is the factory default setting. No pages will be collated. • The On setting stacks the print job sequentially. • Both settings print the entire job the number of times specified by the Copy menu setting.
Quality Mixed Text Photo	Specifies the printed output quality Note: Mixed is the factory default setting.
Density <level indicator> ■ □ □ □ □ ■ ■ □ □ □ ■ ■ ■ □ □ ■ ■ ■ ■ □ ■ ■ ■ ■ ■	Lightens or darkens the printed output Note: 3 is the factory default setting.
Reduce/Enlarge 100% 2in1 A4-LTR-LGL 4in1 A4-LTR-LGL 200% 400% Custom 25-400% 25% 50% 78% LGL>LTR 83% LGL>A4 94% A4>LTR 97% LTR>A4	Reduces or enlarges the printed output Notes: <ul style="list-style-type: none"> • 100% is the factory default setting. • Choosing 4in1 A4-LTR-LGL or 2in1 A4-LTR-LGL specifies that multiple-page images be printed on one side of a sheet of paper. You can copy either four or two consecutive pages of a multiple-page document onto a single sheet of paper. • Multiple-page print is available only when making copies using the ADF.

Scan Settings menu

Menu item	Description
<p>Document Size</p> <p>LGL 8.5X14 LTR 8.5X11 STMT 5.5X8.5 EXEC 7.25X10.5 A4 210X297 B5 182X257 A5 210X148 Custom</p> <p style="padding-left: 20px;">Inch</p> <p style="padding-left: 40px;">Width 5.5->8.5 Length 5.5->14</p> <p style="padding-left: 20px;">mm</p> <p style="padding-left: 40px;">Width 140->216 Length 140->355</p>	<p>Sets the document size for scanning</p> <p>Note: LTR 8.5X11 or A4 210X297 is the factory default setting, depending on the country code.</p>
<p>MultiPage in a Document</p> <p>Yes No</p>	<p>Sets whether multiple pages are scanned when using the ADF. This mode supports the following file types: PDF and TIFF.</p> <p>Note: Yes is the factory default setting.</p>
<p>Limitless Scan</p> <p>Off On</p>	<p>Lets you scan two or more pages using the scanner glass</p> <p>Note: Off is the factory default setting.</p>
<p>Color Compressed Ratio</p> <p>Low Medium High</p>	<p>Sets the color compression for scanning. A low color compression will result in a higher quality image, but the file size will be larger.</p> <p>Note: Medium is the factory default setting.</p>
<p>Resolution</p> <p>100x100 dpi 150x150 dpi 200x200 dpi 300x300 dpi 400x400 dpi 600x600 dpi</p>	<p>Sets the scanning resolution</p> <p>Note: 300x300 dpi is the factory default setting.</p>
<p>Density</p> <p><level indicator></p> <p>■ □ □ □ □ ■ ■ □ □ □ ■ ■ ■ □ □ ■ ■ ■ ■ □ ■ ■ ■ ■ ■</p>	<p>Lightens or darkens the scan</p> <p>Note: 3 is the factory default setting.</p>

Menu item	Description
Limitation of size of mail 1MB 2MB 3MB 4MB 5MB No Limit	Sets the size limitation for scanned documents Note: 1MB is the factory default setting.

Fax Settings menu

Menu item	Description
TX Settings Immediate TX On Off Next Fax Only Resolution Standard Fine Photo Density Light Normal Dark Pause Key Time xx sec Auto Redial Off On Transmitter Header Off On	Sets the outgoing fax transmission settings Notes: <ul style="list-style-type: none"> • Off is the factory default setting for Immediate TX. • Standard is the factory default setting for Resolution. • Normal is the factory default setting for Density. • On is the factory default setting for Auto Redial. • Set Immediate TX to On to send faxes immediately, without using memory. • Changing the Density lightens or darkens the outgoing fax.

Menu item	Description
<p>RX Settings</p> <p>RX Mode</p> <p> Fax Only</p> <p> Manual</p> <p> FAX/TAD</p> <p>Auto Reduction</p> <p> Off</p> <p> On</p> <p>Ring Count Delay</p> <p> xx times</p> <p>F/T Ring Time</p> <p> xx sec</p>	<p>Sets the incoming fax transmission settings</p> <p>Notes:</p> <ul style="list-style-type: none"> • FAX/TAD is the factory default setting for RX Mode. • 4 times is the factory default setting for Ring Count Delay. • 15 sec is the factory default setting for F/T Ring Time. • Off is the factory default setting for Auto Reduction. • Use Auto Reduction to enable or disable automatic reduction of faxes to fit the paper loaded in the paper tray. • Set the Ring Count Delay to the number of rings before a fax call is answered. Settings for the ring count range from 1–99. • Set the F/T Ring Time to change the length of time (in seconds) the machine rings before switching to a fax receive mode. The ring time settings range from 5–99 seconds.
<p>Tray Settings</p> <p>Tray Use: Fax</p> <p> Auto</p> <p> Tray 1 Only</p> <p> Tray 2 Only</p>	<p>Sets the default tray to use for incoming faxes</p> <p>Note: Auto is the factory default setting.</p>
<p>Delete Document</p> <p>Memory Job Clear</p> <p> Clear</p> <p> Not Clear</p> <p>All Clear</p> <p> Clear</p> <p> Not Clear</p>	<p>Specifies which documents to clear from memory</p> <p>Notes:</p> <ul style="list-style-type: none"> • Use Memory Job Clear to select an individual job to clear. • Use All Clear to clear all jobs from memory.

Menu item	Description
Comm Settings ECM TX Off On ECM RX Off On Dial Tone Detect Detection No Detection TX Speed 33.6 kbps 14.4 kbps 9.6 kbps 7.2 kbps 4.8 kbps 2.4 kbps RX Speed 33.6 kbps 14.4 kbps 9.6 kbps 7.2 kbps 4.8 kbps 2.4 kbps	Sets the fax communication settings Notes: <ul style="list-style-type: none"> • On is the factory default setting for ECM TX. • On is the factory default setting for ECM RX. • 33.6 is the factory default setting for TX Speed. • 33.6 is the factory default setting for RX Speed. • Change the TX Speed to select the speed at which the printer starts transmitting a fax. • Change the RX Speed to select the speed at which the printer starts receiving a fax.
Report Settings TX Report Error Only Error Only lmg Always Printed Always Prt lmg Not Printed Activity Report Auto Print Not Printed	Specifies when a fax transmission report is printed Notes: <ul style="list-style-type: none"> • Error Only lmg is the factory default setting for TX Report. • Auto Print is the factory default setting for Activity Report. • Auto Print automatically prints an activity report every 100 faxes sent or received.

Fax Directory menu

Menu item	Description
Quick Dial Entry 01= to 20= Fax # Entry Fax Name Entry	Sets a name and fax number for each Quick Dial number. Up to 20 names and numbers can be stored for one-touch Quick Dial access.

Menu item	Description
Speed Dial Entry 01= to 50= Fax # Entry Fax Name Entry	Sets a name and fax number for each Speed Dial number. Up to 50 names and numbers can be stored in the Speed Dial directory.

Machine Settings menu

Menu item	Description
Speaker Volume Keypad Volume 0–3 Ring Volume 0–3 Line Mon. Vol 0–3 Job End Tone Vol 0–3 Job Error Tone Vol 0–3 Alarm Volume 0–3	Specifies the volume for the selected menu item Notes: <ul style="list-style-type: none"> • 1 is the factory default setting for the Keypad Volume. • 2 is the factory default setting for all other volume settings. • Setting the volume to 0 turns the volume off.
Paper Settings Paper Type Tray1 Paper Plain paper Thin paper Middle Thick Thick1 Thick2 Label Special paper Transparency Tray2 Paper Plain paper Thin paper Middle Thick Tray2 Left Margin -3.5 mm – +3.5 mm	Specifies the paper type loaded in each tray, and Tray 2 margin settings Notes: <ul style="list-style-type: none"> • Plain Paper is the factory default setting for Tray 1 and Tray 2. • Tray2 Left Margin adjusts the left margin of Tray 2. • All Tray 2 menu items appear only if Tray 2 is installed.

Menu item	Description
<p>Job Timeout</p> <p>USB</p> <p>Off</p> <p>On</p> <p>xxx sec</p> <p>LAN</p> <p>Off</p> <p>On</p> <p>xxx sec</p>	<p>Sets the amount of time in seconds the printer waits to receive an end-of-job message before canceling the remainder of the print job</p> <p>Notes:</p> <ul style="list-style-type: none"> • On (60 sec) is the factory default setting for USB. • On (270 sec) is the factory default setting for LAN. • When the timer expires, any partially printed page still in the printer is printed, and then the printer checks to see if any new print jobs are waiting.
<p>Toner Saver Mode</p> <p>Off</p> <p>On</p>	<p>Reduces the amount of toner used for graphics and images</p> <p>Note: Off is the factory default setting.</p>

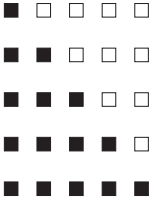
Menu item	Description
<p>Supplies Info</p> <p>Toner</p> <ul style="list-style-type: none"> Black Life <ul style="list-style-type: none"> Init. 1000 Pages Std. 2500 Pages High 5000 Pages Magenta Life <ul style="list-style-type: none"> Init. 1000 Pages Std. 1500 Pages High 5000 Pages Yellow <ul style="list-style-type: none"> Init. 1000 Pages Std. 1500 Pages High 5000 Pages Cyan <ul style="list-style-type: none"> Init. 1000 Pages Std. 1500 Pages High 5000 Pages <p>Cartridge Type</p> <ul style="list-style-type: none"> Black <ul style="list-style-type: none"> Init. 1000 Pages Std. 2500 Pages High 5000 Pages Magenta <ul style="list-style-type: none"> Init. 1000 Pages Std. 1500 Pages High 5000 Pages Yellow <ul style="list-style-type: none"> Init. 1000 Pages Std. 1500 Pages High 5000 Pages Cyan <ul style="list-style-type: none"> Init. 1000 Pages Std. 1500 Pages High 5000 Pages <p>Waste Toner Pack</p> <ul style="list-style-type: none"> Waste Pack Life <p>OPC Belt</p> <ul style="list-style-type: none"> OPC Belt Life Replace OPC Belt <ul style="list-style-type: none"> Not Replaced Replaced <p>Fuser Unit</p> <ul style="list-style-type: none"> Fuser Unit Life Replace Fuser <ul style="list-style-type: none"> Not Replaced Replaced 	<p>Displays the remaining life information for supplies, and allows supply life to be reset when supplies are replaced</p> <p>Notes:</p> <ul style="list-style-type: none"> The option to replace the photodeveloper belt and fuser appears only when the life information is low or empty. The life information is displayed using a meter that shows one of five different levels (shown below). A full bar (five shaded boxes) indicates the supply item is new or full. An empty bar (five empty boxes) indicates the supply item is low or empty. <div style="text-align: center;">  </div>
<p>Scanner Carriage</p> <ul style="list-style-type: none"> Move to Lock <ul style="list-style-type: none"> Not Execute Execute 	<p>When you select Execute, the scanner is moved to the home position. Then, you can move the carriage switch (on the lower left corner of the scanner glass) to the Lock position for transportation.</p> <p>Note: Not Execute is the factory default setting.</p>

Network Settings menu

Menu item	Description
Ethernet MAC LINK Status LINK Setting Auto 100M Full Duplex 100M Half Duplex 10M Full Duplex 10M Half Duplex	Lets you view the current Ethernet information, and change the LINK settings. Note: Auto is the factory default LINK setting.
IP Configuration DHCP Activated Off On IP Address xxx.xxx.xxx.xxx Subnet Mask xxx.xxx.xxx.xxx Gateway xxx.xxx.xxx.xxx IP Source DHCP AUTO IP Manual Default IP	Lets you view or change the current TCP/IP address information and network settings. Notes: <ul style="list-style-type: none"> • On is the factory default DHCP setting. • 270 sec is the factory default TCP Idle Timeout. • Default IP is the factory default IP Source. • IP Address, Subnet Mask, and Gateway are four-field IP addresses.

Reports Print menu

Menu item	Description
Configuration Page <none>	Prints a configuration page with printer information, settings information, supply information, and network information
Activity Report <none>	Prints a Fax activity report
Memory List <none>	Prints a memory status report
Quick Dial List <none>	Prints the Quick Dial list

Menu item	Description
Speed Dial List No Sort Sort by Name	Prints the Speed Dial list Notes: <ul style="list-style-type: none"> • No Sort prints the Speed Dial list in numerical order. • Sort by Name prints the Speed Dial list in alphabetical order.
Scan Directory List <none>	Prints the Scan Directory list
Scan Transmission Log <none>	Prints a log of all scan activity
Demo Page <none>	Prints a demo page
Maintenance Page <none>	Prints a maintenance page with printer statistics, maintenance information, and color quality troubleshooting

Admin Settings menu

Menu item	Description
Date/Time Setup Date/Time Setting Date Setting Year Month Day Date Format MM/DD/YYYY DD/MM YYYY YYYY MM/DD Time Setting 24 Hours 12 Hours	Sets the date and time options
User Settings User Fax # User Name	Sets the user's name and fax number
TEL Line Type Tone Pulse 10PPS Pulse 20PPS	Sets the telephone line type
PBX Selection PSTN PBX	Sets the network type of fax Note: PSTN is the factory default setting.

Menu item	Description
PBX Access Digit xxx	Specifies an outside line dispatch number Notes: <ul style="list-style-type: none"> • 9 is the factory default setting. • Any number from 1–999 can be used.
Default Mode Copy Fax	Specifies whether the printer will be in Fax mode or Copy mode following either of these two events: <ul style="list-style-type: none"> • The printer is turned on. • The Auto Clear setting times out. Note: Copy is the factory default setting.
Auto Clear Off On 30 sec 1 min. 2 min. 3 min. 5 min. 10 min.	Sets whether the printer automatically returns to the Default Mode setting after the set amount of time if no operation is done during that time Notes: <ul style="list-style-type: none"> • On (30 sec) is the factory default setting. • Off disables the Auto Clear function.
Power Saver Off On Wait 1–240min	Sets the amount of time in minutes the printer waits after a job is printed before it goes into a reduced power state Notes: <ul style="list-style-type: none"> • On (30 min.) is the factory default setting. • Lower settings conserve more energy, but may require longer warm-up times. • Select the lowest setting if the printer shares an electrical circuit with room lighting or you notice lights flickering in the room. • Select a high setting if the printer is in constant use. Under most circumstances, this keeps the printer ready to print with minimum warm-up time.
Display Language ENGLISH FRENCH GERMAN ITALIAN SPANISH	Selects the language of the text appearing on the display
Country Code <list of country codes>	Sets the country or region where the printer is being used Note: The Country Code must be set correctly for the fax function to work properly.

Menu item	Description
<p>Setting Default</p> <p>Clear Menu Settings Not Execute Execute</p> <p>Clear Network Settings Not Execute Execute</p> <p>Clear Fax Directory Not Execute Execute</p> <p>Clear Logs Not Execute Execute</p>	<p>Sets the factory defaults for specific printer settings</p> <p>Note: Clear Menu Settings returns all settings to the factory default settings except the display language, country or region, date and time, network settings, and fax directory entries.</p>
<p>Admin Menu Lock</p> <p>Off On Password xxxx</p>	<p>Lets an administrator lock the Admin Settings menu, Fax Directory menu, and Network Settings menu to keep administrative menu settings from being changed</p> <p>Notes:</p> <ul style="list-style-type: none"> • Off is the factory default setting. • A 4-digit PIN number can be assigned to access the locked menus.

Understanding printer messages

List of status and error messages

<x> Toner Empty: Replace Toner <x>

The specified toner cartridge is empty. Remove the specified cartridge, and then install a new one.

<xx> Service Call: <message>

- 1 Turn the printer off.
- 2 Unplug the power cord from the wall outlet.
- 3 Check all cable connections.
- 4 Connect the power cord to a properly grounded outlet.
- 5 Turn the printer back on.

If the service message appears again, contact Customer Support, and report the message.

ADF Cover Open: Close ADF Cover

Close the ADF cover to clear the message.

ADF Jam: Open ADF Cover and Clear Jam

Clear the ADF to resume printing.

Answering

The printer is answering a fax call. Wait for the message to clear.

Awaiting Redial

The printer is preparing to redial a fax number after a failed dialing attempt or busy signal. Wait for the message to clear.

Busy

After a fax number was dialed, the printer received a busy signal. The fax number will be redialed.

Calibrating

Wait for the message to clear.

Cannot Copy: Cancel 2in1/4in1-Copy to Exec/B5

When you are using “2in1 A4-LTR-LGL” and “4in1 A4-LTR-LGL” copy options, executive and B5 paper sizes are not supported.

Cannot Copy: Cancel Copy to Small Paper

Small paper sizes are not supported for copy jobs. When copying, only A4, letter, legal, and B5 paper sizes are supported.

Cover Open: Close Front Cover

Close the front door to clear the message.

Cover Open: Close OPC Cover

The door (OPC Cover) under the scanner unit is open. Close the OPC door to clear the message.

Cover Open: Close Rear Cover

Close the rear door to clear the message.

Communication Error

A network communication error has occurred. Check network settings and connections.

Dial Fail

The printer attempted to dial the fax number and send the fax several times but could not connect with the destination fax machine. Try sending the fax again.

Dialing

The printer is dialing a fax number. Wait for the message to clear.

Duplicate IP: Duplicate IP Address Found

The IP address has been duplicated.

Disconnect the LAN cable, change the IP address using the Network Settings menu, and then reconnect the LAN cable.

Email Size Over: Email Size Limit Exceeded

The scan job is too large to send. Increase the Limitation Of Size Of Mail setting, and then scan the job again. If the message occurs again, lower the scan resolution to decrease the job size.

Fail to Connect to Server: Server Connection Failed

A network communication error has occurred. Check network settings and connections.

Fuser Life: Replace Fuser

- 1 Replace the fuser unit.
- 2 From the Machine Settings menu, reset the fuser counter.

Incoming Call

The printer is preparing to answer a fax call. Wait for the message to clear.

Initializing

Initial diagnostics are running. Wait for the message to clear.

Job #

The scanner is busy. Wait for the message to clear.

Memory Full

There is insufficient memory to complete the current copy job. Cancel the job, and then try copying it again.

Memory Near Full

There may be insufficient memory to complete the current print job. If the job fails to print, cancel the job, and then try sending it again.

Missing: Install Fuser Unit

The fuser unit is missing. Install the fuser unit.

Missing: Install OPC Belt

The photodeveloper cartridge is missing or not installed correctly. Install or reseal the photodeveloper cartridge.

Missing: Install Toner <x>

The specified toner cartridge is missing. Install the specified toner cartridge.

Missing: Install Transfer Roller

The transfer roller is missing or not installed correctly. Install or reseal the transfer roller.

No Memory: Out of Memory

There is insufficient memory to complete the current print job. Cancel the job, and then try sending it again.

No Response

A signal from the destination fax machine was not received. The fax number will be redialed.

OPC Belt Life: Replace OPC Belt

- 1 Replace the photodeveloper cartridge.
- 2 From the Machine Settings menu, reset the photodeveloper cartridge (OPC Belt) counter.

OPC Exhausted: Replace OPC Belt

- 1 Replace the photodeveloper cartridge.
- 2 From the Machine Settings menu, reset the photodeveloper cartridge (OPC Belt) counter.

Paper Change: Load Tray<x> <paper type>

The printer is set to print on a paper type that is different from what is loaded in Tray 1. Load Tray 1 with the correct paper type, or change the paper type settings in the Machine Settings menu or Print Properties to match what is loaded in Tray 1.

Paper Empty: Load Tray <x> <paper type>

The specified paper tray is empty, or an incorrect paper type is loaded. Load the specified tray with the specified paper type.

Paper Error: Load Tray 1 <paper type>

The printer is set to print on a paper type that is different from what is loaded in Tray 1. Load Tray 1 with the correct paper type, or change the paper type settings in the Machine Settings menu to match what is loaded in Tray 1.

Paper Jam A1/Paper Jam A2/Paper Jam B/Paper Jam C

Clear the paper path to resume printing.

PC Printing

Wait for the message to clear.

PF<x> Kit Life: Replace PF Kit <x>

The paper feed roller and separator pad in Tray <x> are near exhaustion. Replace the paper feed roller and separator pad for the specified tray.

Place Next Page: Then Press Set

Place the next page to be scanned on the scanner glass, and then press √.

Please Wait

Wait for the message to clear.

Printing

The printer is printing a fax. Wait for the message to clear.

Ready

The printer is ready to receive print jobs.

Receiving

The printer is receiving a fax. Wait for the message to clear.

RX Comm Error

An incoming fax transmission error has occurred. Wait for the fax to be re-sent.

Scan Calibration Error

- Make sure the scanner lock is unlocked, and then reset the printer.
- Check for debris on the scanner glass (which includes the document glass and the ADF glass), and then reset the printer.

If the message appears again, contact Customer Support, and report the message.

Scan Lock Error: Unlock Scanner

The scanner is locked. Open the scanner cover, and then unlock the scanner.

Scan Memory Near Full

There may be insufficient memory to complete the current scan job. If the job fails to scan, cancel the job, and then try scanning it again.

Scan Network Disconnect

Check the network cable connection. Make sure the network cable is securely connected to the computer and the printer.

Scan USB Disconnect

Check the USB cable connection. Make sure the USB cable is securely connected to the computer and the printer.

Scanning Page

The scanner is busy. Wait for the message to clear.

Send Email Notify: Send Email Notification

An alert has been activated on the printer that requests an e-mail notification to be sent.

Sending File

The scanned image is being sent to the selected destination. Wait for the message to clear.

Set Correct Paper

Not all paper sizes are supported for faxing. An unsupported paper size is loaded in the tray. Load a supported paper size.

Sleep

The printer is saving power while it waits for the next print job.

TAD Answering

An answering machine has answered the call. Wait for the message to clear.

Toner Error: Install Supported Toner Cartridge

An invalid toner cartridge is installed. Remove the toner cartridge, and then install a supported one.

Transmitting

The printer has connected with the receiving fax machine and is sending a fax. Wait for the message to clear.

Toner Low <xxxx>

The toner cartridge(s) of color “x”—K (black), M (magenta), Y (yellow), or C (cyan)—will soon be exhausted. The specified toner cartridge can print approximately 100–125 pages, depending on the coverage of the toner color, after this message first appears.

When **Toner Low <xxxx>** appears or when the print becomes faded, follow these steps to extend the life of the toner cartridge(s):

- 1 Remove the toner cartridge(s).
- 2 Firmly shake the cartridge(s) side-to-side and front-to-back several times to redistribute toner.
- 3 Reinsert the toner cartridge(s) and continue printing.

Note: Repeat this procedure multiple times until the print remains faded, and then replace the toner cartridge(s).

Tray <x> Missing: Insert Tray

Tray 1 and/or Tray 2 is missing. Insert the specified tray(s) into the printer.

TR Belt Life: Replace Transfer Belt

The transfer belt is exhausted. Install a new transfer belt.

TR Kit Life: Replace PQ Kit

The transfer roller and transfer belt cleaning roller are exhausted. Install a new transfer roller and a new transfer belt cleaning roller.

TX Comm Error

An outgoing fax transmission error has occurred. Resend the fax.

Warming up

Wait for the message to clear.

Waste Pack Full

The waste toner bottle is full or missing. If it is full, replace it using the instruction sheet that came with the replacement waste toner bottle. If it is missing, install it.

Maintaining the printer

Periodically, certain tasks are required to maintain optimum print quality.

Storing supplies

Choose a cool, clean storage area for the printer supplies. Store supplies right side up in their original packing until you are ready to use them.

Do not expose supplies to:

- Direct sunlight
- Temperatures above 35°C (95°F)
- High humidity above 80%
- Salty air
- Corrosive gases
- Heavy dust

Conserving toner

Toner Saver mode enables you to conserve toner. When Toner Saver mode is enabled, print may appear lighter. To enable Toner Saver mode:

- 1 From the control panel, press ▲.
- 2 Press ▲ or ▼ repeatedly until **Machine Settings** appears, and then press √.
- 3 Press ▲ or ▼ repeatedly until **Toner Saver Mode** appears, and then press √.
- 4 Press ▲ or ▼ repeatedly until **On** appears, and then press √.
- 5 Press ⓧ to return to the **Ready** state.

Note: Toner Saver mode is not recommended when you are printing photos or grayscale images.

Cleaning the printer

If print quality problems such as streaking occur, follow these cleaning procedures.

Warning: Do not put water directly on the printer or use ammonia-based cleaners or volatile solvents, such as thinner, on the printer.

Cleaning the exterior of the printer

- 1 Make sure that the printer is turned off and unplugged from the wall outlet.



CAUTION: To avoid the risk of electric shock, unplug the power cord from the wall outlet and disconnect all cables to the printer before proceeding.

- 2 Remove paper from the paper support and paper exit tray.
- 3 Dampen a clean, lint-free cloth with water.

Warning: Do not use household cleaners or detergents, as they may damage the finish of the printer.

4 Wipe only the outside of the printer, making sure to remove any ink residue that has accumulated on the paper exit tray.

Warning: Using a damp cloth to clean the interior may cause damage to your printer.

5 Make sure the paper support and paper exit tray are dry before beginning a new print job.

Cleaning the scanner glass

Clean the scanner glass if you encounter print quality problems, such as streaks on copied or scanned images.

1 Slightly dampen a soft, lint-free cloth or paper towel with water.

2 Open the scanner cover.

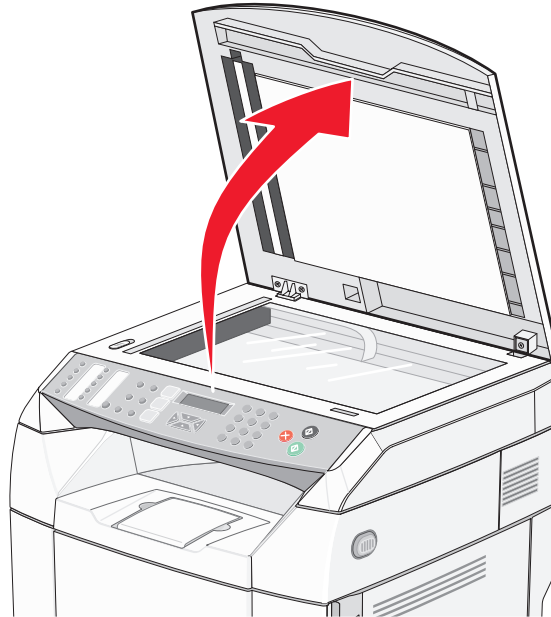

3 Wipe the scanner glass (which includes the document glass and ADF glass) until it is clean and dry.

4 Wipe the white underside of the scanner cover and the white plastic input guides until they are clean and dry.

Note: The white plastic input guides are located on the scanner cover underneath the ADF on the left side.

5 Close the scanner cover.

Cleaning the dust-proof glass

Clean the dust-proof glass if you encounter print quality problems.

- 1 Turn the printer off.
- 2 Pull the front door release latch forward, and gently lower the front door.

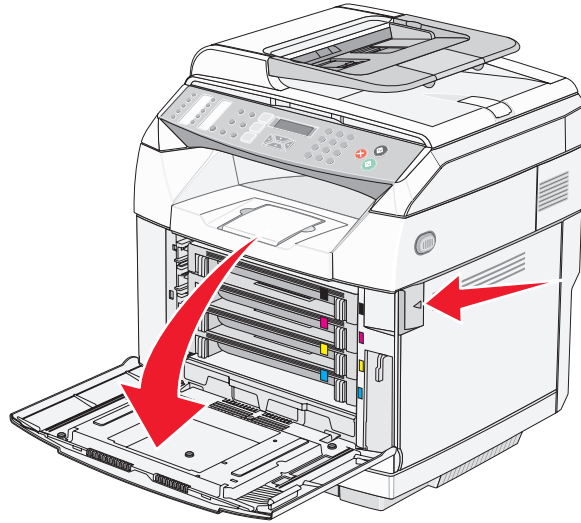

- 3 Remove the toner cartridges one at a time.

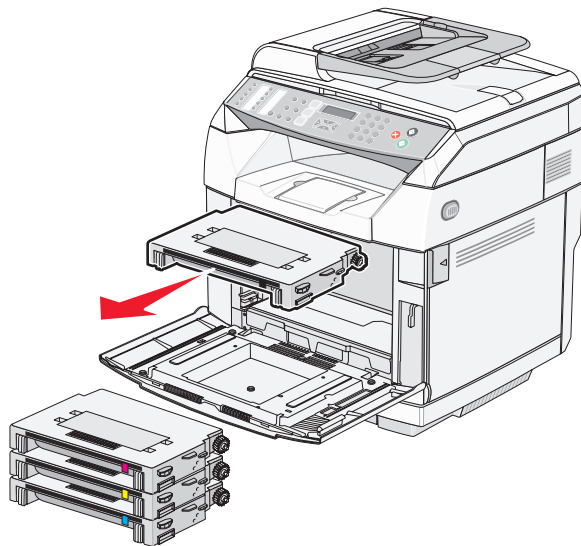

4 Open the top door.

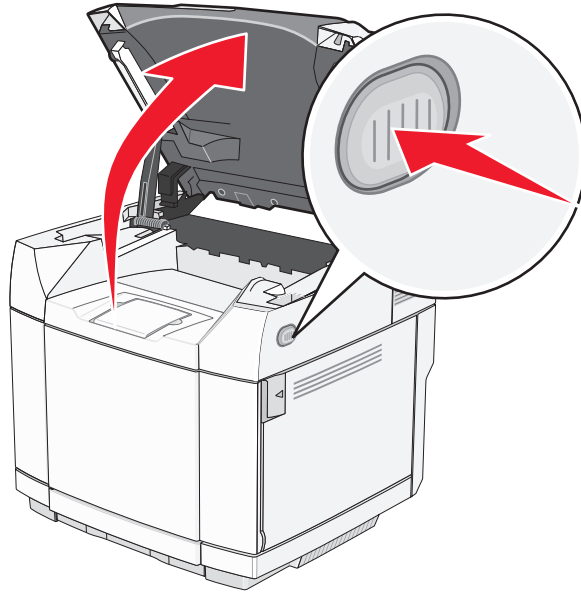

5 Push the latches toward each other to release the photodeveloper cartridge.

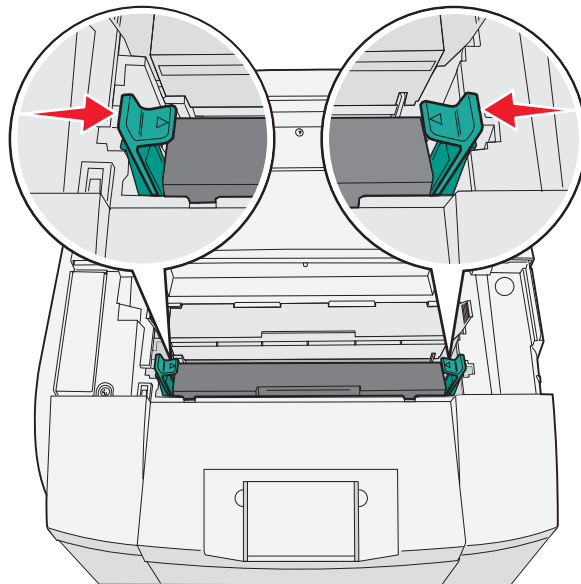

6 Grasp the handle, and pull the photodeveloper cartridge straight up and out.

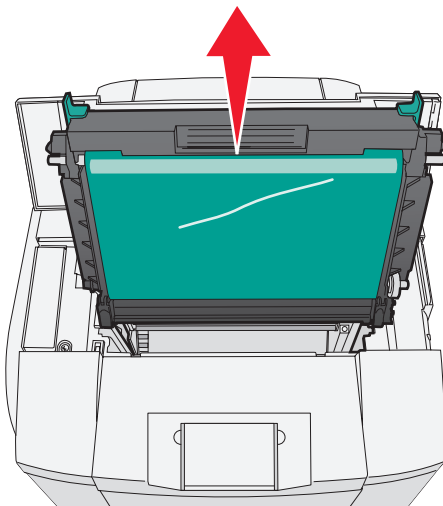

7 Pull on the tabs to lift the dust-proof glass cover.

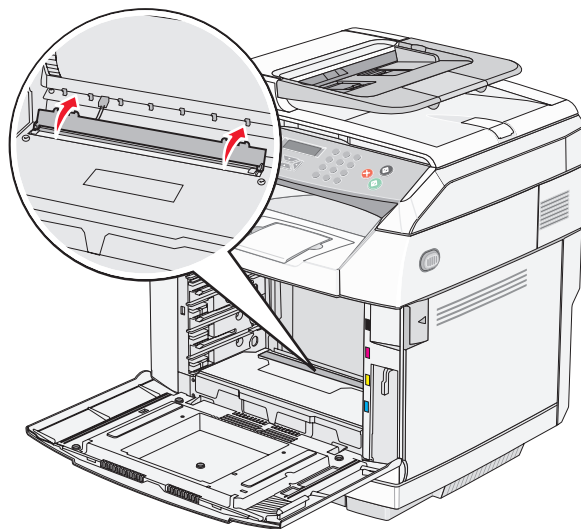

8 Gently wipe the dust-proof glass using a clean, dry, lint-free cloth.

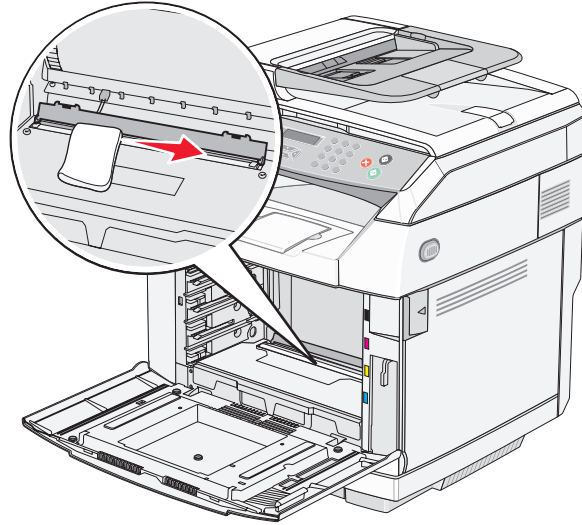

9 Push the dust-proof glass cover down.

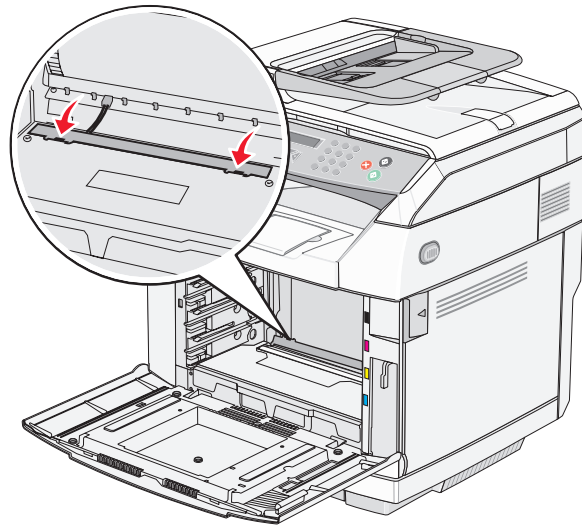

10 Replace the photodeveloper cartridge.

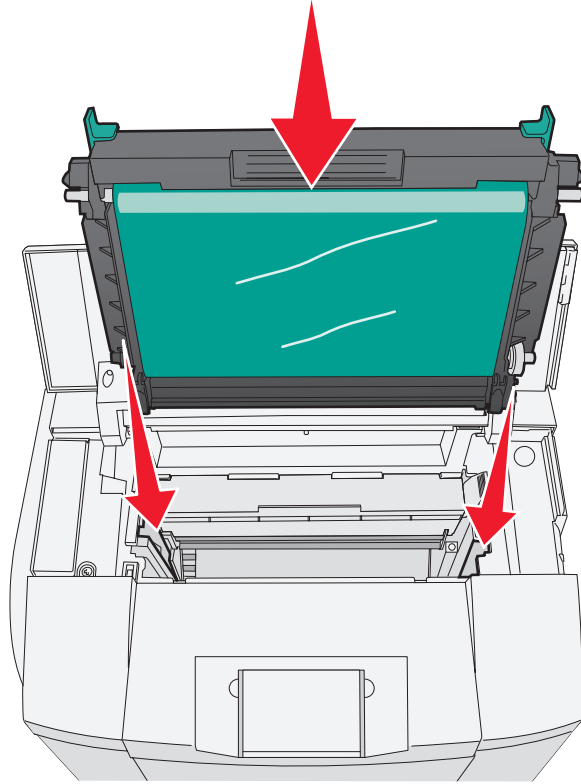

11 Push the latches away from each other to lock the photodeveloper cartridge into place.

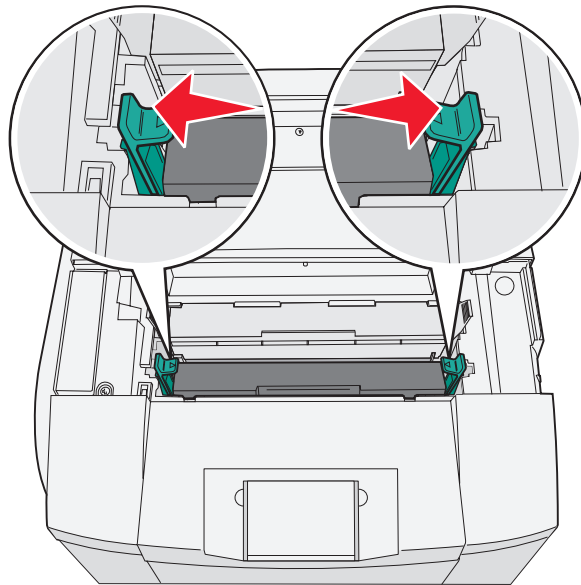

12 Close the top door.

13 Install the toner cartridges one at a time.

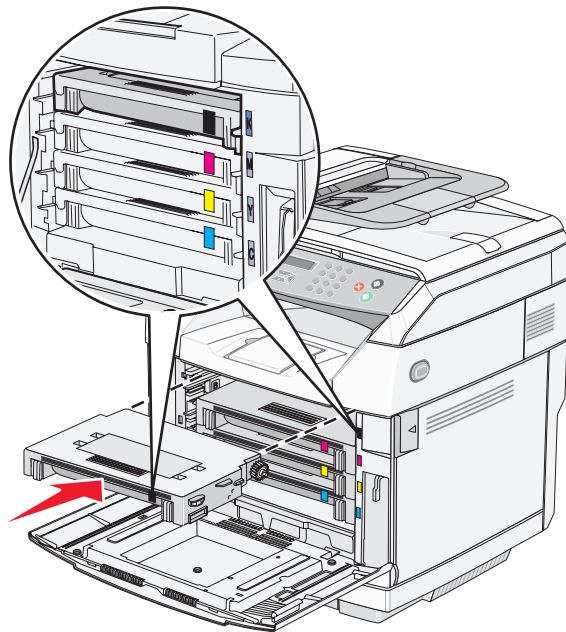

14 Close the front door.

15 Turn the printer on.

Ordering supplies

To order supplies in the U.S., contact Lexmark at 1-800-539-6275 for information about Lexmark authorized supplies dealers in your area. In other countries or regions, visit the Lexmark Web Site at www.lexmark.com or contact the place where you purchased the printer.

Note: All life estimates for printer supplies assume printing on letter- or A4-size plain paper.

Ordering toner cartridges

When **Toner Low** <xxxx> appears, order the specified new toner cartridge(s). The toner cartridge(s) of color “x”—K(black), Y(yellow), M(magenta), or C(cyan)—will soon be exhausted. The specified toner cartridge can print approximately 100–125 pages, depending on the coverage of the toner color, after the message first appears.

When **Toner Low** <xxxx> appears or when the print becomes faded, you may be able to extend the life of the toner cartridge(s):

- 1 Remove the toner cartridge(s).
- 2 Firmly shake the cartridge(s) side-to-side and front-to-back several times to redistribute toner.
- 3 Reinsert the toner cartridge(s) and continue printing.

Note: Repeat this procedure multiple times until the print remains faded, and then replace the cartridge(s).

The recommended toner cartridges specifically designed for your printer are:

Part name	Part number	For printer(s)
Cyan High Yield Toner Cartridge	C500H2CG	C500/X500/X502
Magenta High Yield Toner Cartridge	C500S2MG	C500/X500/X502

Part name	Part number	For printer(s)
Yellow High Yield Toner Cartridge	C500H2YG	C500/X500/X502
Black High Yield Toner Cartridge	C500H2KG	C500/X500/X502
Cyan Toner Cartridge	C500S2CG	C500/X500/X502
Magenta Toner Cartridge	C500S2MG	C500/X500/X502
Yellow Toner Cartridge	C500S2YG	C500/X500/X502
Black Toner Cartridge	C500S2KG	C500/X500/X502

Ordering a fuser

When **Fuser Life: Replace Fuser** appears, replace the fuser immediately. For installation information, see the documentation that came with the fuser.

Part name	Part number
Fuser	C500X28G (120 V/50–60 Hz) C500X29G (220–240 V/50–60 Hz)

Ordering a photodeveloper cartridge

When **OPC Belt Life: Replace OPC** appears, replace the photodeveloper cartridge (OPC belt) immediately. For installation information, see the documentation that came with the photodeveloper cartridge.

Part name	Part number
Photodeveloper cartridge	C500X26G

Ordering a waste toner bottle

When **Waste Pack Full: Replace Waste Toner Pack** appears, order a replacement waste toner bottle.

Part name	Part number
Waste toner bottle	C500X27G

Moving the printer

Before moving the printer

CAUTION: The printer weighs 35 kg (77 lb); therefore, it requires at least three people to lift it safely. Use the handholds on the sides of the printer to lift it, and make sure your fingers are not under the printer when you set it down.

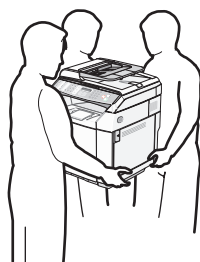

Follow these guidelines to avoid personal injury or printer damage:

- Use at least two people to lift the printer.
- Before moving the printer:
 - Turn it off using the power switch.
 - Unplug the power cord from the wall outlet.
 - Disconnect all cords and cables from the printer.
 - Remove all printer options.

Warning: Damage to the printer caused by improper moving is not covered by the printer warranty.

Locking the scanner

- 1 From the control panel, press ▲.
- 2 Press ▲ or ▼ repeatedly until **Machine Settings** appears, and then press √.
- 3 Press ▲ or ▼ repeatedly until **Scanner Carriage** appears, and then press √.
- 4 Press ▲ or ▼ repeatedly until **Move to Lock** appears, and then press √.
- 5 Press ▲ or ▼ repeatedly until **Execute** appears, and then press √.
The scanner moves to the home position.
- 6 Press ⊗ to return to the **Ready** state.
- 7 Open the scanner cover.

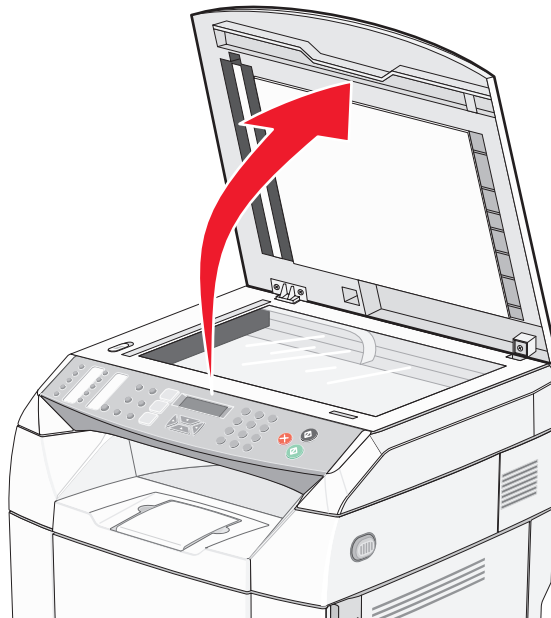

8 Move the Scanner lock switch to the locked position.

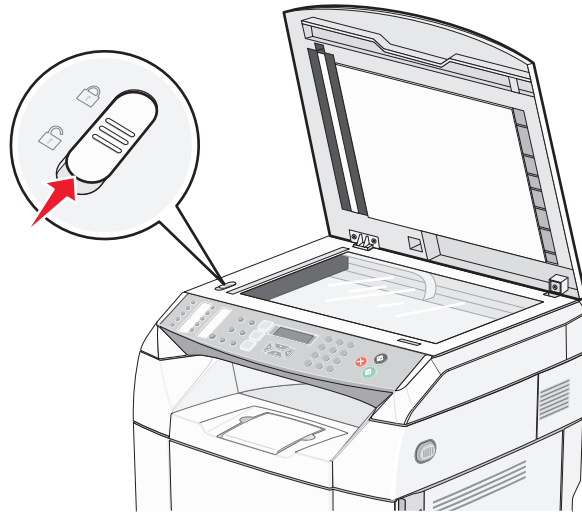

9 Close the scanner cover.

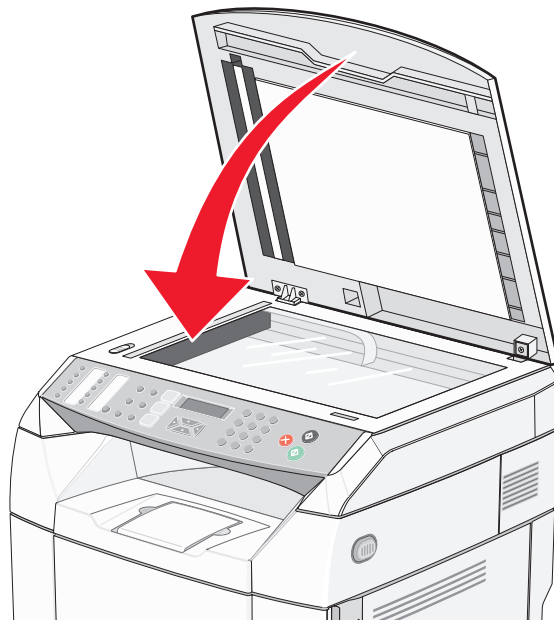

Removing the printer from the 530-sheet drawer

- 1** Turn the printer off, and then unplug the power cord from the wall outlet.
- 2** Disconnect all cables from the back of the printer.

- 3** Remove the right side cover by starting at the back of the printer and gently pulling each of the four slots off of its matching tab as you work your way to the front of the printer.

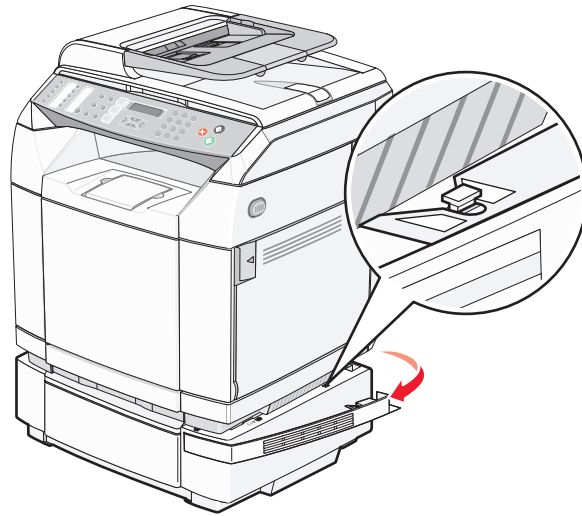

- 4** Remove the left side cover by starting at the back of the printer and gently pulling each of the four slots off of its matching tab as you work your way to the front of the printer.



5 Loosen the right thumbscrew, and remove the right bracket.

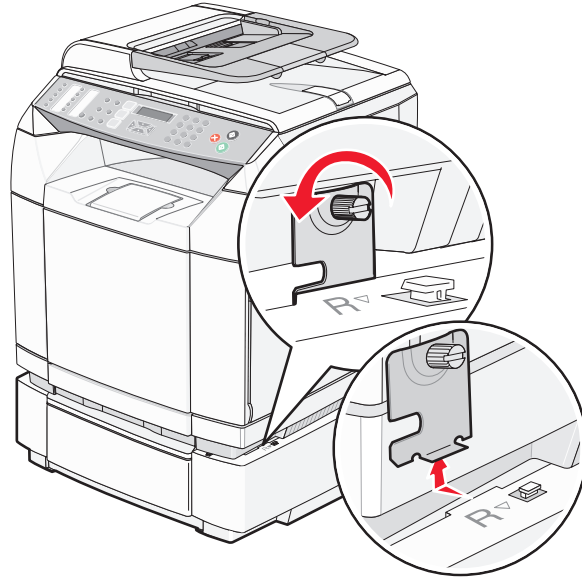

6 Loosen the left thumbscrew, and remove the left bracket.

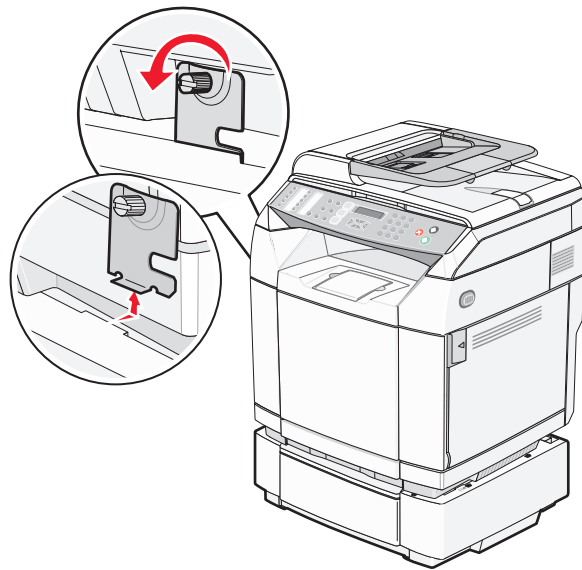

7 Lift the printer off the drawer, and set the printer aside.

⚠ CAUTION: The printer weighs 35 kg (77 lb), and requires at least three people to lift it safely. Use the handholds on the sides of the printer to lift it, and make sure your fingers are not under the printer when you set it down.

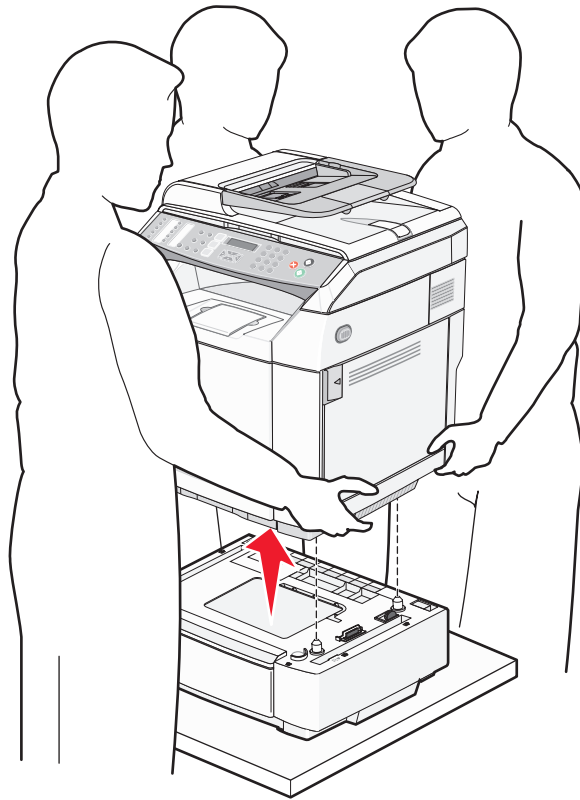

Moving the printer to another location

The printer and options can be safely moved to another location by following these precautions:

- Any cart used to move the printer must have a surface able to support the full footprint of the printer. Any cart used to move the options must have a surface able to support the dimensions of the options.
- Keep the printer in an upright position.
- Avoid severe jarring movements.

Setting the printer up in a new location

When the printer is set up, allow clearance around it as shown.

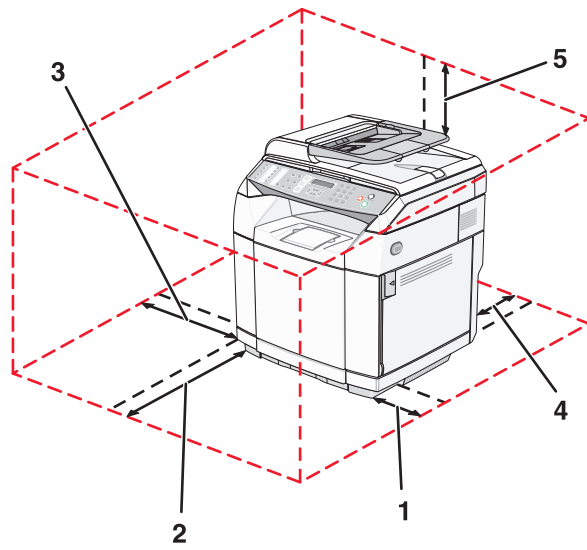

1	50 cm (8.0 in.)
2	70 cm (28.0 in.)
3	20 cm (8.0 in.)
4	25 cm (10.0 in.)
5	304.8 mm (12.0 in.)

Administrative support

Locking the administrator menus

Since many people often use a printer, a support person may choose to lock the Admin Settings menu, Fax Directory menu, and Network Settings menu so that administrative settings cannot be changed from the control panel.

- 1 Make sure the printer is on and **Ready** appears.
- 2 From the control panel, press ▲.
- 3 Press ▲ or ▼ repeatedly until **Admin Settings** appears, and then press √.
- 4 Press ▲ or ▼ repeatedly until **Admin Menu Lock** appears, and then press √.
- 5 Press ▲ or ▼ repeatedly until **On** appears, and then press √.
Note: On disables the use of the Admin Settings menu, and Off enables the use of the Admin Settings menu. If the Admin Settings menu is disabled, they can be accessed only with the use of a PIN.
- 6 You are prompted to enter a password (PIN). Use the keypad to enter a 4-digit PIN, and then press √.
- 7 Press ❌ to return to the **Ready** state.

Changing the administrator menus password

In order to change the administrator password (PIN), the administrator menus must already be locked. To change the password:

- 1 Make sure the printer is on and **Ready** appears.
- 2 From the control panel, press ▲.
- 3 Press ▲ or ▼ repeatedly until **Admin Settings** appears, and then press √.
- 4 Type the current password, and then press √.
- 5 Press ▲ or ▼ repeatedly until **Admin Menu Lock** appears, and then press √.
- 6 Press ▲ or ▼ repeatedly to choose **On**, and then press √.
- 7 Type the new password, and then press √.
- 8 Press ❌ to return to the **Ready** state.

Adjusting Power Saver

- 1 Make sure the printer is on and **Ready** appears.
- 2 From the control panel, press ▲.
- 3 Press ▲ or ▼ repeatedly until **Admin Settings** appears, and then press √.
- 4 Press ▲ or ▼ repeatedly until **Power Saver** appears, and then press √.
- 5 Press ▲ or ▼ repeatedly until **On** appears, and then press √.

- 6 Using the keypad, enter the number of minutes for the printer to wait before it enters Power Saver mode. Available settings range from 1–240 minutes.
- 7 Press \checkmark .
- 8 Press \times to return to the **Ready** state.

Restoring factory default settings

Menu settings marked with an asterisk (*) indicate the active settings. You can restore the original printer settings, often referred to as the *factory default settings*.

- 1 Make sure the printer is on and **Ready** appears.
- 2 From the control panel, press \blacktriangle .
- 3 Press \blacktriangle or \blacktriangledown repeatedly until **Admin Settings** appears, and then press \checkmark .
- 4 Press \blacktriangle or \blacktriangledown repeatedly until **Setting Default** appears, and then press \checkmark .
- 5 Press \blacktriangle or \blacktriangledown repeatedly until **Clear Menu Settings** appears, and then press \checkmark .
- 6 Press \blacktriangle or \blacktriangledown repeatedly until **Execute** appears, and then press \checkmark .
Executing... appears briefly.
- 7 Press \times to return to the **Ready** state.

Note: All settings return to the factory default settings except the display language, country or region, date and time, network settings, and fax directory entries.

Setting the Default mode

Setting the Default mode specifies whether the printer will be in Fax mode or Copy mode following either of these two events:

- The printer is turned on.
- The Auto Clear setting times out.

Note: Auto Clear is off by default.

To set the Default mode:

- 1 Make sure the printer is on and **Ready** appears.
- 2 From the control panel, press \blacktriangle .
- 3 Press \blacktriangle or \blacktriangledown repeatedly until **Admin Settings** appears, and then press \checkmark .
- 4 Press \blacktriangle or \blacktriangledown repeatedly until **Default Mode** appears, and then press \checkmark .
- 5 Press \blacktriangle or \blacktriangledown repeatedly to choose **Copy** or **Fax**, and then press \checkmark .
- 6 Press \times to return to the **Ready** state.

Note: Copy is the factory default setting.

Turning on Auto Clear

Auto Clear specifies whether the printer automatically returns to the Default Mode setting after the set amount of time if no operation is done during that time. To turn on Auto Clear and set the time-out duration:

- 1 Make sure the printer is on and **Ready** appears.
- 2 From the control panel, press ▲.
- 3 Press ▲ or ▼ repeatedly until **Admin Settings** appears, and then press √.
- 4 Press ▲ or ▼ repeatedly until **Auto Clear** appears, and then press √.
- 5 Press ▲ or ▼ repeatedly until **On** appears, and then press √.
- 6 Press ▲ or ▼ repeatedly to choose the time duration, and then press √.
- 7 Press ❌ to return to the **Ready** state.

Using the Embedded Web Server

If the printer is installed on a network, the Embedded Web Server can be used for the following functions:

- Checking the status of the printer
- Checking the status of the printer supplies
- Setting up the scan directory
- Setting up the fax Speed Dial list
- Configuring network settings
- Creating an Embedded Web Server administrator password
- Printing reports
- Restoring the factory default settings of the printer
- Backing up Embedded Web Server settings

To access the Embedded Web Server:

- 1 Open a Web browser.
- 2 In the address bar, type the network printer or print server IP address, and then press **Enter**.

Troubleshooting

Online customer support

Customer support is available on the Lexmark Web site at www.lexmark.com

Checking an unresponsive printer

If your printer is not responding, make sure:

- The power cord is plugged into the printer and a properly grounded electrical outlet.
- The electrical outlet is not turned off by any switch or breaker.
- The printer is not plugged into any surge protectors, uninterrupted power supplies, or extension cords.
- Other electrical equipment plugged into the outlet is working.
- The printer is turned on.
- The printer cable is securely attached to the printer and the host computer, print server, option, or other network device.

Once you have checked each of these possibilities, turn the printer off and then back on. This often fixes the problem.

Solving printing problems

Multiple-language PDFs do not print

The documents contain unavailable fonts.

- 1 Open the document you want to print in Adobe Acrobat.
- 2 Click the printer icon.
The Print dialog appears.
- 3 Select **Print as image**.
- 4 Click **OK**.

Control panel display is blank

The printer self test failed. Turn the printer off, wait about 10 seconds, and then turn the printer back on.

If **Warming Up** and **Ready** do not appear, turn the printer off and contact Customer Support.

Jobs do not print

These are possible solutions. Try one or more of the following:

Make sure the printer is ready to print

Make sure **Ready** or **Power Saver** appears on the display before sending a job to print. Press  to return the printer to the **Ready** state.

Check to see if the paper tray is empty

Load paper in the tray.

Make sure the correct printer software is installed

- Verify that you are using the correct printer software.
- If you are using a USB port, make sure you are running Windows 98/ME, Windows 2000, Windows XP, or Windows Server 2003 and using Windows 98/ME, Windows 2000, Windows XP, or Windows Server 2003 compatible printer software.

Make sure the internal print server is installed properly and working

- Make sure the internal print server is properly installed and that the printer is connected to the network. For more information about installing a network printer, click **View User's Guide and Documentation** on the *Software and Documentation CD*.
- Print a network setup page and check that the status shows **Connected**. If the status is **Not Connected**, check the network cables, and then try printing the network setup page again. Contact your system support person to make sure the network is functioning correctly.

Copies of the printer software are also available on the Lexmark Web site at www.lexmark.com.

Make sure you are using a recommended USB, serial, or Ethernet cable

For more information, see the supplies section of the *User's Guide*, or contact the place where you bought the printer.

Make sure printer cables are securely connected

Check the cable connections to the printer and print server to make sure they are secure.

For more information, see the setup documentation that came with the printer.

Job takes longer than expected to print

The job is too complex.

Reduce the complexity of your print job by eliminating the number and size of fonts, the number and complexity of images, and the number of pages in the job.

Tray linking does not work

Make sure to do all of the following:

- Load both Tray 1 and Tray 2 with the same paper size and type.
- From Print Properties, change the Paper source to Auto select.

Unexpected page breaks occur

The job has timed out. Set the Job Timeout to a higher value:

- 1 Make sure the printer is on and **Ready** appears.
- 2 From the control panel, press ▲.
- 3 Press ▲ or ▼ repeatedly until **Machine Settings** appears, and then press √.
- 4 Press ▲ or ▼ repeatedly until **Job Timeout** appears, and then press √.
- 5 Press ▲ or ▼ repeatedly until **USB** or **Network** appears, and then press √.
- 6 Press ▲ or ▼ repeatedly until **on** appears, and then press √.
- 7 Press ▲ or ▼ repeatedly to choose a value (in seconds), or use the keypad to directly enter the value, and then press √.
- 8 Press ⊗ to return to the **Ready** state.

Solving copy problems

Copier does not respond

These are possible solutions. Try one or more of the following:

Are there any error messages on the display?

Clear any error messages.

Check the power

Make sure the printer is plugged in, the power is on, and **Ready** appears.

Scanner unit does not close

Make sure there are no obstructions:

- 1 Lift the scanner unit.
- 2 Remove any obstruction keeping the scanner unit open.
- 3 Lower the scanner unit.

Poor copy quality

These are some examples of poor copy quality:

- Blank pages
- Checkerboard pattern
- Distorted graphics or pictures
- Missing characters
- Faded print
- Dark print
- Skewed lines
- Smudges
- Streaks
- Unexpected characters
- White lines in print

These are possible solutions. Try one or more of the following:

Are there any error messages on the display?

Clear any error messages.

Is the toner low?

When **Toner Low** <xxxx> appears or when the print becomes faded, follow these steps to extend the life of the toner cartridge(s):

- 1 Remove the toner cartridge(s).
- 2 Firmly shake the cartridge(s) side-to-side and front-to-back several times to redistribute toner.
- 3 Reinsert the toner cartridge(s) and continue printing.

Note: Repeat this procedure multiple times until the print remains faded, and then replace the toner cartridge(s).

Is the scanner glass dirty?

Clean the scanner glass with a clean, lint-free cloth dampened with water.

Is the copy too light or too dark?

Adjust the density of the copy:

- 1 From the control panel, press ▲.
- 2 Press ▲ or ▼ repeatedly until **Copy Settings** appears, and then press √.
- 3 Press ▲ or ▼ repeatedly until **Density** appears, and then press √.
- 4 Press ▲ or ▼ repeatedly to lighten or darken the copy, and then press √.
- 5 Press ✖ to return to the **Ready** state.

Note: Copy density can also be temporarily changed by pressing the Lighter/Darker button on the control panel. When the printer power is reset, the printer returns to the default settings.

Adjust the copy quality

- 1 From the control panel, press ↶.
- 2 Press ▲ or ▼ repeatedly until **Copy Settings** appears, and then press √.
- 3 Press ▲ or ▼ repeatedly until **Quality** appears, and then press √.
- 4 Press ▲ or ▼ repeatedly until **Mixed**, **Text**, or **Photo** appears, and then press √.
- 5 Press ✖ to return to the **Ready** state.

Note: Copy quality can also be temporarily changed by pressing the Image Quality button on the control panel. When the printer power is reset, the printer returns to the default settings.

Check the quality of the original document

Make sure the quality of the original document is satisfactory.

Check the document placement

Make sure the document or photo is loaded facedown on the scanner glass in the upper left corner.

Partial document or photo copies

These are possible solutions. Try one or more of the following:

Check the document placement

Make sure the document or photo is loaded facedown on the scanner glass in the upper left corner.

Check the Paper Size setting

Make sure the Paper Size setting matches the paper loaded in the tray.

Solving scan problems

Scanner does not respond

These are possible solutions. Try one or more of the following:

Are there any error messages on the display?

Clear any error messages.

Check the power

Make sure the printer is plugged in, the power is on, and **Ready** appears.

Check the cable connections

Make sure the network or USB cable is securely connected to the computer and the printer.

Scan was not successful

These are possible solutions. Try one or more of the following:

Check the cable connections

Make sure the network or USB cable is securely connected to the computer and the printer.

An error may have occurred in the program

Turn off and then restart the computer.

Scanning takes too long or freezes the computer

These are possible solutions. Try one or more of the following:

Do you have any other software programs running?

Close all programs not being used.

The scan resolution may be set too high

Select a lower scan resolution.

Poor scanned image quality

These are possible solutions. Try one or more of the following:

Are there any error messages on the display?

Clear any error messages.

Is the scanner glass dirty?

Clean the scanner glass with a clean, lint-free cloth dampened with water.

Adjust the scan resolution

Increase the resolution of the scan for a higher quality output:

- 1 From the control panel, press ▲.
- 2 Press ▲ or ▼ repeatedly until **scan settings** appears, and then press √.

- 3 Press ▲ or ▼ repeatedly until **Resolution** appears, and then press √.
- 4 Press ▲ or ▼ repeatedly to choose a higher resolution, and then press √.
- 5 Press ⓧ to return to the **Ready** state.

Check the quality of the original document

Make sure the quality of the original document is satisfactory.

Check the document placement

Make sure the document or photo is loaded facedown on the scanner glass in the upper left corner.

Partial document or photo scans

These are possible solutions. Try one or more of the following:

Check the document placement

Make sure the document or photo is loaded facedown on the scanner glass in the upper left corner.

Check the Paper Size setting

Make sure the Paper Size setting matches the paper loaded in the tray.

Cannot scan from a computer

These are possible solutions. Try one or more of the following:

Are there any error messages on the display?

Clear any error messages.

Check the power

Make sure the printer is plugged in, the power is on, and **Ready** appears.

Check the cable connections

Make sure the network or USB cable is securely connected to the computer and the printer.

Solving fax problems

Cannot send or receive a fax

These are possible solutions. Try one or more of the following:

Are there any error messages on the display?

Clear any error messages.

Check the power

Make sure the printer is plugged in, the power is on, and **Ready** appears.

Check the printer connections

Make sure the cable connections for the following hardware are secure, if applicable:

- Telephone
- Handset
- Answering machine

Check the telephone wall jack

- 1 Plug a telephone into the wall jack.
- 2 Listen for a dial tone.
- 3 If you do not hear a dial tone, plug a different telephone into the wall jack.
- 4 If you still do not hear a dial tone, plug a telephone into a different wall jack.
- 5 If you hear a dial tone, connect the printer to that wall jack.

Review this digital phone service checklist

The fax modem is an analog device. Certain devices can be connected to the printer so that digital telephone services can be used.

- If you are using an ISDN telephone service, connect the printer to an analog telephone port (an R-interface port) on an ISDN terminal adapter. For more information and to request an R-interface port, contact your ISDN provider.
- If you are using DSL, connect to a DSL filter or router that will support analog use. For more information, contact your DSL provider.
- If you are using a PBX telephone service, make sure you are connecting to an analog connection on the PBX. If none exists, consider installing an analog telephone line for the fax machine.

Is there a dial tone?

- Place a test call to the telephone number to which you want to send a fax to make sure that it is working correctly.
- If the telephone line is being used by another device, wait until the other device is finished before sending a fax.
- If you are using the On Hook Dial feature, turn up the volume to verify a dial tone.

Temporarily disconnect other equipment

To ensure the printer is working correctly, connect it directly to the telephone line. Disconnect any answering machines, computers with modems, or telephone line splitters.

Check for jams

Clear any jams, and then make sure that **Ready** appears.

Temporarily disable Call Waiting

Call Waiting can disrupt fax transmissions. Disable this feature before sending or receiving a fax. Call your telephone company to obtain the keypad sequence for temporarily disabling Call Waiting.

Do you have Voice Mail service?

Voice Mail offered through your local telephone company may disrupt fax transmissions. To enable both Voice Mail and the printer to answer calls, you may want to consider adding a second telephone line for the printer.

Check the country code

- 1 Make sure the printer is on and **Ready** appears.
- 2 From the control panel, press ▲.
- 3 Press ▲ or ▼ repeatedly until **Admin Settings** appears, and then press √.
- 4 Press ▲ or ▼ repeatedly until **Country Code** appears, and then press √.
- 5 Look down at the **Country Code** menu item to see the user default setting indicated by an asterisk (*).
- 6 If you want to change the county code:
 - a Press ▲ or ▼ repeatedly until the country or region where you are operating the printer appears, and then press √.
 - b Press ❌ to return to the **Ready** state.
- 7 If you do not want to change the country code, press ❌ to return to the **Ready** state.

Is the printer memory full?

- 1 Dial the fax number.
- 2 Scan the original document one page at a time.

Can send but not receive faxes

These are possible solutions. Try one or more of the following:

Is there paper in the paper tray(s)?

Make sure paper is loaded in the tray(s).

Check the Ring Count Delay settings

The Ring Count Delay sets the number of times the phone line rings before the printer answers in Fax Only mode. If you have extension phones on the same line as the printer, or subscribe to the telephone company's Distinctive Ring service, keep the Ring Count Delay setting at 4.

- 1 From the control panel, press ▲.
- 2 Press ▲ or ▼ repeatedly until **Fax Settings** appears, and then press √.
- 3 Press ▲ or ▼ repeatedly until **RX Settings** appears, and then press √.
- 4 Press ▲ or ▼ repeatedly until **Ring Count Delay** appears, and then press √.
- 5 Press ▲ or ▼ repeatedly to set how many times the phone line rings before the printer answers (0–99), and then press √.
- 6 Press ❌ to return to the **Ready** state.

When the number of rings you set is detected, the printer automatically receives the incoming fax. Set the Ring Count Delay to 0 to disable the line from ringing.

Is the toner low?

When **Toner Low** <XXXX> appears or when you experience faded print, you may be able to extend the life of the toner cartridge(s):

- 1 Remove the toner cartridge(s).
- 2 Firmly shake the cartridge(s) side-to-side and front-to-back several times to redistribute toner.
- 3 Reinsert the toner cartridge(s) and continue printing.

Repeat this procedure multiple times until the print remains faded, and then replace the cartridge(s).

Can receive but not send faxes

These are possible solutions. Try one or more of the following:

Is the printer in Fax mode?

From the control panel, press  to put the printer in Fax mode.

Is the document loaded properly?

Load the original document faceup, short edge first into the ADF or facedown on the scanner glass in the upper left corner.

Note: Do not load postcards, photos, small items, transparencies, photo paper, or thin media (such as magazine clippings) into the ADF. Place these items on the scanner glass.

Make sure Quick Dial or Speed Dial is set up properly

- Check to make sure Quick Dial or Speed Dial has been programmed for the number that you want to dial.
- As an alternative, dial the telephone number manually.

Received fax has poor print quality

These are possible solutions. Try one or more of the following:

Can the document be re-sent?

Ask the person who sent you the fax to:

- Check that the quality of the original document is satisfactory.
- Resend the fax. There may have been a problem with the quality of the telephone line connection.
- Increase the fax scan resolution, if possible.

Is the toner low?

When **Toner Low** <XXXX> appears or when you experience faded print, you may be able to extend the life of the toner cartridge(s):

- 1 Remove the toner cartridge(s).
- 2 Firmly shake the cartridge(s) side-to-side and front-to-back several times to redistribute toner.
- 3 Reinsert the cartridge(s) and continue printing.

Repeat this procedure multiple times until the print remains faded, and then replace the cartridge(s).

Make sure the fax transmission speed is not set too high

Decrease the incoming fax transmission speed:

- 1 From the control panel, press .
- 2 Press ▲.
- 3 Press ▲ or ▼ repeatedly until **Fax Settings** appears, and then press √.
- 4 Press ▲ or ▼ repeatedly until **Comm Settings** appears, and then press √.
- 5 Press ▲ or ▼ repeatedly until **RX Speed** appears, and then press √.
- 6 Press ▲ or ▼ repeatedly until the fax speed you want appears, and then press √.
- 7 Press ✖ to return to the **Ready** state.

Solving option problems

Option does not operate correctly or quits after it is installed

These are possible solutions. Try one or more of the following:

Reset the printer

Turn the printer off, wait for about 10 seconds, and then turn the printer on.

Check to see if the option is connected to the printer

- 1 Turn the printer off.
- 2 Unplug the printer.
- 3 Check the connection between the option and the printer.

Make sure the option is installed

In Print Properties, verify that all the printer configuration settings are correct. If an option does not appear in Print Properties, it is not installed correctly.

Make sure the option is selected

From the program you are using, select the option. Mac OS 9 users should make sure the printer is set up in the Chooser.

Drawers

Make sure the paper is loaded correctly

- 1 Open the paper tray.
- 2 Check for paper jams or misfeeds.
- 3 Make sure paper guides are aligned against the edges of the paper.
- 4 Make sure the paper tray closes properly.
- 5 Close the door.

Reset the printer

Turn the printer off. Wait 10 seconds. Turn the printer back on.

Solving paper feed problems

Paper frequently jams

These are possible solutions. Try one or more of the following:

Check the paper

Use recommended paper and other specialty media. For more information, see the chapter about paper and specialty media guidelines.

Make sure there is not too much paper in the paper tray

Make sure the stack of paper you load does not exceed the maximum stack height indicated in the tray or on the multipurpose feeder.

Check the paper guides

Move the guides in the tray to the correct positions for the paper size loaded.

Has the paper absorbed moisture due to high humidity?

- Load paper from a fresh package.
- Store paper in its original wrapper until you use it.

Paper jam message remains after jam is cleared

The paper path is not clear. Clear paper from the entire paper path, and then close any open doors.

Solving print quality problems

The information in the following topics may help you solve print quality problems. If these suggestions still do not correct the problem, call Customer Support. You may have a printer part that requires adjustment or replacement.

Repeating defects

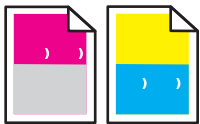

These are possible solutions. Try one or more of the following:

Check to see if marks occur repeatedly only in one color and multiple times on a page

Replace the toner cartridge if the defects occur every 35 mm (1.38 in.).

Check to see if marks occur across the page repeatedly in all colors

Replace the photodeveloper cartridge if the defects occur:

- 35 mm (1.38 in.)
- 95 mm (3.74 in.)
- Once per page

Replace the fuser if the defects occur every:

- 95 mm (3.74 in.)
- 128 mm (5.04 in.)

Color misregistration

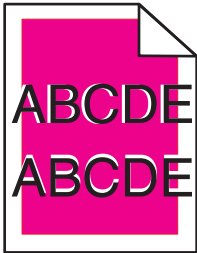

Color has shifted outside of the appropriate area or has been superimposed over another color area.

- Remove and reinstall the toner cartridges.
- Remove and reinstall the photodeveloper cartridge.

Light colored line, white line, or incorrectly colored line

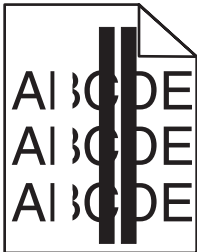

These are possible solutions. Try one or more of the following:

Clean the dust-proof glass

The dust-proof glass may be dirty.

Is a toner cartridge defective?

Replace the toner cartridge causing the line.

Is a photodeveloper cartridge defective?

Replace the photodeveloper cartridge.

Smeared vertical print

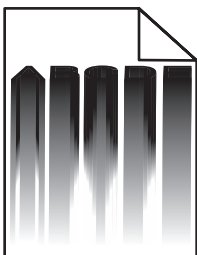

Make sure there is no paper jammed behind the photodeveloper cartridge:

- 1 Press the button on the right side of the printer to release the scanner unit.
- 2 Lift the scanner unit, and then open the top cover.
- 3 Remove the photodeveloper cartridge.
- 4 Remove any loose paper from the photodeveloper cartridge housing.
- 5 Install the photodeveloper cartridge.
- 6 Close the top cover, and then close the scanner unit.

Note: A paper jam message may not occur if there is a jam behind the photodeveloper cartridge. Along with the smeared print, there may be paper scraping sounds coming from the photodeveloper cartridge housing.

Streaked horizontal lines

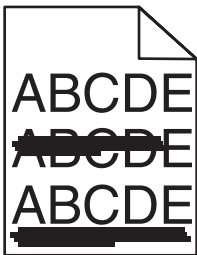

These are possible solutions. Try one or more of the following:

Is a toner cartridge defective or empty?

Replace the toner cartridge causing the line.

Is the fuser defective or worn?

Replace the fuser.

Streaked vertical lines

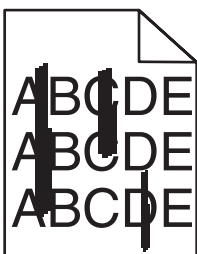

These are possible solutions. Try one or more of the following:

Is the toner smeared?

Try feeding from another tray.

Is a toner cartridge defective?

Replace the toner cartridge causing the streaks.

Print is too light

These are possible solutions. Try one or more of the following:

Make sure the Color Adjustment settings are not too light

From Print Properties, select a different Color Adjustment setting before sending the job to print.

Note: This solution applies to Windows users only.

Check the Media Type setting

From Print Properties, make sure the Media Type setting matches the paper loaded in the tray.

Is the toner low?

When **Toner Low <xxxx>** appears or when the print becomes faded, follow these steps to extend the life of the toner cartridge(s):

- 1 Remove the toner cartridge(s).
- 2 Firmly shake the cartridge(s) side-to-side and front-to-back several times to redistribute toner.
- 3 Reinsert the toner cartridge(s) and continue printing.

Note: Repeat this procedure multiple times until the print remains faded, and then replace the toner cartridge(s).

Is a toner cartridge defective?

Replace the toner cartridge.

Print irregularities

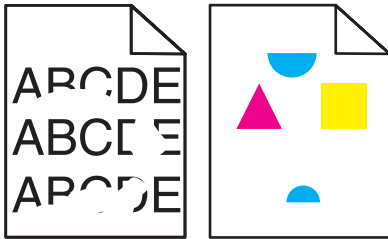

These are possible solutions. Try one or more of the following:

Has the paper absorbed moisture due to high humidity?

- Load paper from a fresh package.
- Store paper in its original wrapper until you use it.

Make sure the Media Type setting matches the paper loaded in the tray

From Print Properties, change the Media Type setting to match the paper loaded in the tray.

Check the paper

Avoid textured paper with rough finishes.

Is the toner low?

When **Toner Low** <xxxx> appears or when the print becomes faded, follow these steps to extend the life of the toner cartridge(s):

- 1 Remove the toner cartridge(s).
- 2 Firmly shake the cartridge(s) side-to-side and front-to-back several times to redistribute toner.
- 3 Reinsert the toner cartridge(s) and continue printing.

Note: Repeat this procedure multiple times until the print remains faded, and then replace the toner cartridge(s).

Is the fuser defective or worn?

Replace the fuser.

Print is too dark

These are possible solutions. Try one or more of the following:

Make sure the Color Adjustment settings are not too dark

From Print Properties, select a different Color Adjustment setting before sending the job to print.

Note: This solution applies to Windows users only.

Is a toner cartridge defective?

Replace the toner cartridge.

Transparency print quality is poor

These are possible solutions. Try one or more of the following:

Make sure the transparencies you are using meet the printer specifications

Use only transparencies recommended by the printer manufacturer.

Make sure the Media Type setting is set to Transparency

From Print Properties, change the Media Type setting to Transparency.

Gray background

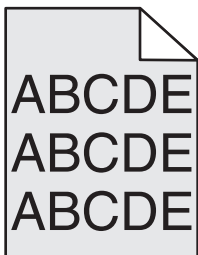

A toner cartridge is defective. Replace the toner cartridge.

Uneven print density

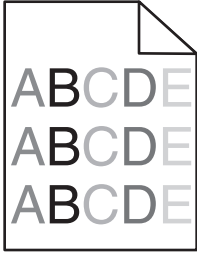

These are possible solutions. Try one or more of the following:

Is a toner cartridge defective?

Replace the toner cartridge.

Is the photodeveloper cartridge defective?

Replace the photodeveloper cartridge.

Ghost images



These are possible solutions. Try one or more of the following:

Is the photodeveloper cartridge defective?

Replace the photodeveloper cartridge.

Check the Media Type setting

From Print Properties, change the Media Type setting to match the paper loaded in the tray.

Incorrect margins

Check to see if the paper guides in the selected tray are set for a different paper size than what is loaded in the tray. If so, move the guides in the tray to the proper positions for the size loaded.

Skewed print

Check the paper guides

Move the guides in the tray to the correct positions for the paper size loaded.

Check the paper

Make sure you are using paper that meets the printer specifications.

Blank pages

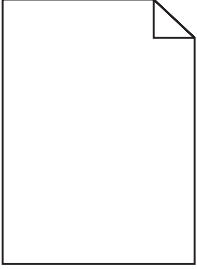

These are possible solutions. Try one or more of the following:

Is the toner low?

When **Toner Low <xxxx>** appears or when the print becomes faded, follow these steps to extend the life of the toner cartridge(s):

- 1** Remove the toner cartridge(s).
- 2** Firmly shake the cartridge(s) side-to-side and front-to-back several times to redistribute toner.
- 3** Reinsert the toner cartridge(s) and continue printing.

Note: Repeat this procedure multiple times until the print remains faded, and then replace the toner cartridge(s).

Is the toner cartridge defective or empty?

Replace the toner cartridge.

Remove the packaging materials from the toner cartridge and reinstall it

For more information, see the setup documentation that came with the printer.

Clipped images

These are possible solutions. Try one or more of the following:

Check the paper guides

Move the guides in the tray to the correct positions for the paper size loaded.

Make sure the Media Type setting matches the paper loaded in the tray

From Print Properties, change the Media Type setting to match the paper loaded in the tray.

Check the Paper Size setting

Make sure the Paper Size setting matches the paper loaded in the tray.

Solid color pages

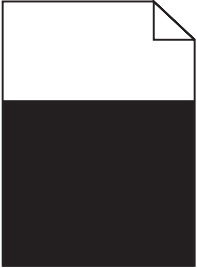

These are possible solutions. Try one or more of the following:

Is a toner cartridge defective?

Replace the toner cartridge.

Does the printer need to be serviced?

Contact Customer Support.

Paper curl

These are possible solutions. Try one or more of the following:

Make sure the Media Type setting matches the paper loaded in the tray

From Print Properties, change the Media Type setting to match the paper loaded in the tray.

Has the paper absorbed moisture due to high humidity?

- Load paper from a fresh package.
- Store paper in its original wrapper until you are ready to use it.

Toner specks

These are possible solutions. Try one or more of the following:

Is the toner low?

When **Toner Low** <XXXX> appears or when the print becomes faded, follow these steps to extend the life of the toner cartridge(s):

- 1 Remove the toner cartridge(s).
- 2 Firmly shake the cartridge(s) side-to-side and front-to-back several times to redistribute toner.
- 3 Reinsert the toner cartridge(s) and continue printing.

Note: Repeat this procedure multiple times until the print remains faded, and then replace the toner cartridge(s).

Is the fuser defective or worn?

Replace the fuser.

Is there toner in the paper path?

If there is excess toner in the paper path, contact Customer Support.

Toner rubs off

These are possible solutions. Try one or more of the following:

Check the Media Type setting

From Print Properties, change the Media Type setting to match the paper loaded in the tray.

Is the fuser defective or worn?

Replace the fuser.

FAQ about color printing

What is RGB color?

Red, green, and blue light can be added together in various amounts to produce a large range of colors observed in nature. For example, red and green can be combined to create yellow. Televisions and computer monitors create colors in this manner. RGB color is a method of describing colors by indicating the amount of red, green, or blue needed to produce a certain color.

What is CMYK color?

Cyan, magenta, yellow, and black inks or toners can be printed in various amounts to produce a large range of colors observed in nature. For example, cyan and yellow can be combined to create green. Printing presses, inkjet printers, and color laser printers create colors in this manner. CMYK color is a method of describing colors by indicating the amount of cyan, magenta, yellow, and black needed to reproduce a particular color.

How is color specified in a document to be printed?

Software programs typically specify document color using RGB or CMYK color combinations. Additionally, they commonly let users modify the color of each object in a document. For more information, see the software program Help section.

How does the printer know what color to print?

When a user prints a document, information describing the type and color of each object is sent to the printer. The color information is passed through color conversion tables that translate the color into appropriate amounts of cyan, magenta, yellow, and black toner needed to produce the desired color. The object type information lets different color conversion tables be used for different types of objects. For example, it is possible to apply one type of color conversion table to text while applying a different color conversion table to photographic images.

The printed page appears tinted. Can I slightly adjust the color?

Sometimes a user may consider printed pages to appear tinted (for example, everything printed seems to be too red). This can be caused by environmental conditions, paper type, lighting conditions, or user preference. In these instances, changing the Color Adjustment from Print Properties may be used to create more preferable color. Color Adjustment provides the user with the ability to make subtle adjustments to the amount of toner being used in each color plane. Selecting positive (or negative) values for cyan, magenta, yellow, and black from the Color Adjustment section in Print Properties will slightly increase (or decrease) the amount of toner used for the chosen color. For example, if a user believes the overall printed page to be too red, then decreasing both magenta and yellow could potentially improve color preferences.

My color transparencies seem dark when being projected. Is there anything I can do to improve the color?

This problem most commonly occurs when projecting transparencies with reflective overhead projectors. To obtain the highest projected color quality, transmissive overhead projectors are recommended. Make sure to print on the recommended type of color transparencies.

Contacting Customer Support

When you call Customer Support, describe the problem you are experiencing, the message on the display, and the troubleshooting steps you have already taken to find a solution.

You need to know your printer model type and serial number. For more information, see the label on the inside top front cover of the printer. The serial number is also listed on the menu settings page.

In the U.S. or Canada, call (1-800-539-6275). For other countries/regions, visit the Lexmark Web site at **www.lexmark.com**.

Notices

Product name:

Lexmark X500n

Product name:

Lexmark X502n

Machine type:

7100

Model(s):

010

110

Edition notice

April 2007

The following paragraph does not apply to any country where such provisions are inconsistent with local law: LEXMARK INTERNATIONAL, INC., PROVIDES THIS PUBLICATION "AS IS" WITHOUT WARRANTY OF ANY KIND, EITHER EXPRESS OR IMPLIED, INCLUDING, BUT NOT LIMITED TO, THE IMPLIED WARRANTIES OF MERCHANTABILITY OR FITNESS FOR A PARTICULAR PURPOSE. Some states do not allow disclaimer of express or implied warranties in certain transactions; therefore, this statement may not apply to you.

This publication could include technical inaccuracies or typographical errors. Changes are periodically made to the information herein; these changes will be incorporated in later editions. Improvements or changes in the products or the programs described may be made at any time.

References in this publication to products, programs, or services do not imply that the manufacturer intends to make these available in all countries in which it operates. Any reference to a product, program, or service is not intended to state or imply that only that product, program, or service may be used. Any functionally equivalent product, program, or service that does not infringe any existing intellectual property right may be used instead. Evaluation and verification of operation in conjunction with other products, programs, or services, except those expressly designated by the manufacturer, are the user's responsibility.

For Lexmark technical support, visit support.lexmark.com.

For information on supplies and downloads, visit www.lexmark.com.

If you don't have access to the Internet, you can contact Lexmark by mail:

Lexmark International, Inc.
Bldg 004-2/CSC
740 New Circle Road NW
Lexington, KY 40550

© 2007 Lexmark International, Inc.

All rights reserved.

UNITED STATES GOVERNMENT RIGHTS

This software and any accompanying documentation provided under this agreement are commercial computer software and documentation developed exclusively at private expense.

Trademarks

Lexmark and Lexmark with diamond design are trademarks of Lexmark International, Inc., registered in the United States and/or other countries.

All other trademarks are the property of their respective owners.

Conventions

Note: A *Note* identifies something that could help you.

Warning: A *Warning* identifies something that could damage your product hardware or software.



CAUTION: A *CAUTION* identifies something that could cause you harm.



CAUTION: This type of *CAUTION* indicates that you should *not touch* the marked area.



CAUTION: This type of *CAUTION* indicates a *hot surface*.



CAUTION: This type of *CAUTION* indicates a *shock hazard*.



CAUTION: This type of *CAUTION* indicates a *tipping hazard*.

Federal Communications Commission (FCC) compliance information statement

This product has been tested and found to comply with the limits for a Class B digital device, pursuant to Part 15 of the FCC Rules. Operation is subject to the following two conditions: (1) this device may not cause harmful interference, and (2) this device must accept any interference received, including interference that may cause undesired operation.

The FCC Class B limits are designed to provide reasonable protection against harmful interference when the equipment is operated in a residential installation. This equipment generates, uses, and can radiate radio frequency energy and, if not installed and used in accordance with the instructions, may cause harmful interference to radio communications. However, there is no guarantee that interference will not occur in a particular installation. If this equipment does cause harmful interference to radio or television reception, which can be determined by turning the equipment off and on, the user is encouraged to try to correct the interference by one or more of the following measures:

- Reorient or relocate the receiving antenna.
- Increase the separation between the equipment and receiver.
- Connect the equipment into an outlet on a circuit different from that to which the receiver is connected.
- Consult your point of purchase or service representative for additional suggestions.

The manufacturer is not responsible for radio or television interference caused by using other than recommended cables or by unauthorized changes or modifications to this equipment. Unauthorized changes or modifications could void the user's authority to operate this equipment.

Note: To assure compliance with FCC regulations on electromagnetic interference for a Class B computing device, use a properly shielded and grounded cable such as Lexmark part number 1021294 for USB attach. Use of a substitute cable not properly shielded and grounded may result in a violation of FCC regulations.

Any questions regarding this compliance information statement should be directed to:

Director of Lexmark Technology & Services
Lexmark International, Inc.
740 West New Circle Road
Lexington, KY 40550
(859) 232-3000

Industry Canada compliance statement

This Class B digital apparatus meets all requirements of the Canadian Interference-Causing Equipment Standard ICES-003.

Avis de conformité aux normes de l'industrie du Canada

Cet appareil numérique de classe B est conforme aux exigences de la norme canadienne relative aux équipements pouvant causer des interférences NMB-003.

LAN connection cable notice

To assure compliance with FCC and other regulations on electromagnetic interference for a Class B computing device, the LAN connection cable provided with the printer must be used if a LAN connection is installed. Failure to use this LAN connection cable may result in a violation of FCC or other electromagnetic emission regulations.

European Community (EC) directives conformity

This product is in conformity with the protection requirements of EC Council directives 89/336/EEC, 2006/95/EC, and 1999/5/EC on the approximation and harmonization of the laws of the Member States relating to electromagnetic compatibility, safety of electrical equipment designed for use within certain voltage limits and on radio equipment and telecommunications terminal equipment.

Compliance is indicated by the CE marking.



A declaration of conformity with the requirements of the directives is available from the Director of Manufacturing and Technical Support, Lexmark International, S. A., Boigny, France.

This product satisfies the limits of EN 55022; safety requirements of EN 60950; and the EMC requirements of EN 55024.

Česky	Společnost Lexmark International, Inc. tímto prohlašuje, že výrobek tento výrobek je ve shodě se základními požadavky a dalšími příslušnými ustanoveními směrnice 1999/5/ES.
Dansk	Lexmark International, Inc. erklærer herved, at dette produkt overholder de væsentlige krav og øvrige relevante krav i direktiv 1999/5/EF.
Deutsch	Hiermit erklärt Lexmark International, Inc., dass sich das Gerät dieses Gerät in Übereinstimmung mit den grundlegenden Anforderungen und den übrigen einschlägigen Bestimmungen der Richtlinie 1999/5/EG befindet.
Ελληνική	ΜΕ ΤΗΝ ΠΑΡΟΥΣΑ Η LEXMARK INTERNATIONAL, INC. ΔΗΛΩΝΕΙ ΟΤΙ ΑΥΤΟ ΤΟ ΠΡΟΪΟΝ ΣΥΜΜΟΡΦΩΝΕΤΑΙ ΠΡΟΣ ΤΙΣ ΟΥΣΙΩΔΕΙΣ ΑΠΑΙΤΗΣΕΙΣ ΚΑΙ ΤΙΣ ΛΟΙΠΕΣ ΣΧΕΤΙΚΕΣ ΔΙΑΤΑΞΕΙΣ ΤΗΣ ΟΔΗΓΙΑΣ 1999/5/ΕΚ.
English	Hereby, Lexmark International, Inc., declares that this type of equipment is in compliance with the essential requirements and other relevant provisions of Directive 1999/5/EC.
Español	Por medio de la presente, Lexmark International, Inc. declara que este producto cumple con los requisitos esenciales y cualesquiera otras disposiciones aplicables o exigibles de la Directiva 1999/5/CE.
Eesti	Käesolevaga kinnitab Lexmark International, Inc., et seade see toode vastab direktiivi 1999/5/EÜ põhinõuetele ja nimetatud direktiivist tulenevatele muudele asjakohastele sätetele.
Suomi	Lexmark International, Inc. vakuuttaa täten, että tämä tuote on direktiivin 1999/5/EY oleellisten vaatimusten ja muiden sitä koskevien direktiivin ehtojen mukainen.
Français	Par la présente, Lexmark International, Inc. déclare que l'appareil ce produit est conforme aux exigences fondamentales et autres dispositions pertinentes de la directive 1999/5/CE.
Magyar	Alulírott, Lexmark International, Inc. nyilatkozom, hogy a termék megfelel a vonatkozó alapvető követelményeknek és az 1999/5/EC irányelv egyéb előírásainak.
Íslenska	Hér með lýsir Lexmark International, Inc. yfir því að þessi vara er í samræmi við grunnkröfur og aðrar kröfur, sem gerðar eru í tilskipun 1999/5/EC.
Italiano	Con la presente Lexmark International, Inc. dichiara che questo prodotto è conforme ai requisiti essenziali ed alle altre disposizioni pertinenti stabilite dalla direttiva 1999/5/CE.
Latviski	Ar šo Lexmark International, Inc. deklarē, ka šis izstrādājums atbilst Direktīvas 1999/5/EK būtiskajām prasībām un citiem ar to saistītajiem noteikumiem.
Lietuvių	Šiuo Lexmark International, Inc. deklaruoja, kad šis produktas atitinka esminius reikalavimus ir kitas 1999/5/EB direktyvos nuostatas.
Malti	Bil-preżenti, Lexmark International, Inc., jiddikjara li dan il-prodott huwa konformi mal-ħtiġijiet essenzjali u ma dispożizzjonijiet oħrajn relevanti li jinsabu fid-Direttiva 1999/5/KE.
Nederlands	Hierbij verklaart Lexmark International, Inc. dat het toestel dit product in overeenstemming is met de essentiële eisen en de andere relevante bepalingen van richtlijn 1999/5/EG.
Norsk	Lexmark International, Inc. erklærer herved at dette produktet er i samsvar med de grunnleggende krav og øvrige relevante krav i direktiv 1999/5/EF.

Polski	Niniejszym Lexmark International, Inc. oświadcza, że niniejszy produkt jest zgodny z zasadniczymi wymogami oraz pozostałymi stosownymi postanowieniami Dyrektywy 1999/5/EC.
Português	A Lexmark International Inc. declara que este produto está conforme com os requisitos essenciais e outras disposições da Diretiva 1999/5/CE.
Slovensky	Lexmark International, Inc. týmto vyhlasuje, že tento produkt spĺňa základné požiadavky a všetky príslušné ustanovenia smernice 1999/5/ES.
Slovensko	Lexmark International, Inc. izjavlja, da je ta izdelek v skladu z bistvenimi zahtevami in ostalimi relevantnimi določili direktive 1999/5/ES.
Svenska	Härmed intygar Lexmark International, Inc. att denna produkt står i överensstämmelse med de väsentliga egenskapskrav och övriga relevanta bestämmelser som framgår av direktiv 1999/5/EG.

Noise emission levels

The following measurements were made in accordance with ISO 7779 and reported in conformance with ISO 9296.

Note: Some modes may not apply to your product.

1-meter average sound pressure, dBA	
Printing	69 dBA
Scanning	61 dBA
Copying	68 dBA
Ready	53 dBA

Values are subject to change. See www.lexmark.com for current values.

Waste from Electrical and Electronic Equipment (WEEE) directive



The WEEE logo signifies specific recycling programs and procedures for electronic products in countries of the European Union. We encourage the recycling of our products. If you have further questions about recycling options, visit the Lexmark Web site at www.lexmark.com for your local sales office phone number.

Ozone emissions statement

A standard for ozone emissions has been established by IEC 60950-1. This printer meets the standard.

Federal Communications Commission (FCC) compliance information statement

This equipment complies with Part 68 of the FCC rules and the requirements adopted by the Administrative Council for Terminal Attachments (ACTA). On the back of this equipment is a label that contains, among other information, a product identifier in the format US:AAAEQ##TXXXX. If requested, this number must be provided to your telephone company.

This equipment uses the RJ-11C Universal Service Order Code (USOC) jack.

A plug and jack used to connect this equipment to the premises' wiring and telephone network must comply with the applicable FCC Part 68 rules and requirements adopted by the ACTA. A compliant telephone cord and modular plug is provided with this product. It is designed to be connected to a compatible modular jack that is also compliant. See your setup documentation for more information.

The Ringer Equivalence Number (REN) is used to determine the number of devices that may be connected to a telephone line. Excessive RENs on a telephone line may result in the devices not ringing in response to an incoming call. In most but not all areas, the sum of RENs should not exceed five (5.0). To be certain of the number of devices that may be connected to a line, as determined by the total RENs, contact your local telephone company. For products approved after July 23, 2001, the REN for this product is part of the product identifier that has the format US:AAAEQ##TXXXX. The digits represented by ## are the REN without a decimal point (for example, 03 is a REN of 0.3). For earlier products, the REN is shown separately on the label.

If this equipment causes harm to the telephone network, the telephone company will notify you in advance that temporary discontinuance of service may be required. If advance notice is not practical, the telephone company will notify the customer as soon as possible. You will also be advised of your right to file a complaint with the FCC.

The telephone company may make changes in its facilities, equipment, operations or procedures that could affect the operation of this equipment. If this happens, the telephone company will provide advance notice in order for you to make necessary modifications to maintain uninterrupted service.

If you experience trouble with this equipment, for repair or warranty information, contact Lexmark International, Inc. at www.lexmark.com or your Lexmark representative. If the equipment is causing harm to the telephone network, the telephone company may request that you disconnect the equipment until the problem is resolved.

This equipment contains no user serviceable parts. For repair and warranty information, contact Lexmark International, Inc. See the previous paragraph for contact information.

Connection to party line service is subject to state tariffs. Contact the state public utility commission, public service commission, or corporation commission for information.

If your home has specially wired alarm equipment connected to the telephone line, ensure the installation of this equipment does not disable your alarm equipment. If you have questions about what will disable alarm equipment, consult your telephone company or a qualified installer.

Telephone companies report that electrical surges, typically lightning transients, are very destructive to customer terminal equipment connected to AC power sources. This has been identified as a major nationwide problem. It is recommended that the customer install an appropriate AC surge arrester in the AC outlet to which this device is connected. An appropriate AC surge arrester is defined as one that is suitably rated, and certified by UL (Underwriter's Laboratories), another NRTL (Nationally Recognized Testing Laboratory), or a recognized safety certification body in the country/region of use. This is to avoid damage to the equipment caused by local lightning strikes and other electrical surges.

The Telephone Consumer Protection Act of 1991 makes it unlawful for any person to use a computer or other electronic device, including fax machines, to send any message unless said message clearly contains in a margin at the top or bottom of each transmitted page or on the first page of the transmission, the date and time it is sent and an identification of the business or other entity, or other individual sending the message, and the telephone number of the sending machine or such business, other entity, or individual. (The telephone number provided may not be a 900 number or any other number for which charges exceed local or long-distance transmission charges.)

See your user documentation in order to program this information into your fax machine.

Notice to users of the Canadian telephone network

This product meets the applicable Industry Canada technical specifications. The Ringer Equivalence Number (REN) is an indication of the maximum number of terminals allowed to be connected to a telephone interface. The terminus of an interface may consist of any combination of devices, subject only to the requirement that the sum of the RENs of all the devices does not exceed five. The modem REN is located on the rear of the equipment on the product labeling.

Telephone companies report that electrical surges, typically lightning transients, are very destructive to customer terminal equipment connected to AC power sources. This has been identified as a major nationwide problem. It is recommended that the customer install an appropriate AC surge arrester in the AC outlet to which this device is connected. An appropriate AC surge arrester is defined as one that is suitably rated, and certified by UL (Underwriter's Laboratories), another NRTL (Nationally Recognized Testing Laboratory), or a recognized safety certification body in the country/region of use. This is to avoid damage to the equipment caused by local lightning strikes and other electrical surges.

This equipment uses CA11A telephone jacks.

Avis réservé aux utilisateurs du réseau téléphonique du Canada

Ce produit est conforme aux spécifications techniques d'Industrie Canada. Le numéro REN (ringer equivalence number : numéro d'équivalence de sonnerie) fournit une indication du nombre maximum de terminaux pouvant être connectés à l'interface téléphonique. En bout de ligne, le nombre d'appareils qui peuvent être connectés n'est pas directement limité, mais la somme des REN de ces appareils ne doit pas dépasser cinq. Le numéro REN du modem est indiqué sur l'étiquette produit située à l'arrière de l'équipement.

Les compagnies de téléphone constatent que les surtensions électriques, en particulier celles dues à la foudre, entraînent d'importants dégâts sur les terminaux privés connectés à des sources d'alimentation CA. Il s'agit-là d'un problème majeur d'échelle nationale. En conséquence, il vous est recommandé de brancher un parasurtenseur dans la prise de courant à laquelle l'équipement est connecté. Utilisez un parasurtenseur répondant à des caractéristiques nominales satisfaisantes et certifié par le laboratoire d'assureurs UL (Underwriter's Laboratories), un autre laboratoire agréé de type NRTL (Nationally Recognized Testing Laboratory) ou un organisme de certification agréé dans votre région ou pays. Ceci prévient tout endommagement de l'équipement causé par les orages et autres surtensions électriques.

Cet équipement utilise des prises de téléphone CA11A.

Notice to users of the New Zealand telephone network

The following are special conditions for the Facsimile User Instructions. The grant of a telepermit for any item of terminal equipment indicates only that Telecom has accepted that the item complies with minimum conditions for connection to its network. It indicates no endorsement of the product by Telecom, nor does it provide any sort of warranty. Above all, it provides no assurance that any item will work correctly in all respects with another item of telepermitted equipment of a different make or model, nor does it imply that any product is compatible with all of Telecom's network services.

This equipment shall not be set up to make automatic calls to the Telecom's 111 Emergency Service.

This equipment may not provide for the effective hand-over of a call to another device connected to the same line.

This equipment should not be used under any circumstances that may constitute a nuisance to other Telecom customers.

Some parameters required for compliance with Telecom's telepermit requirements are dependent on the equipment associated with this device. The associated equipment shall be set to operate within the following limits for compliance to Telecom's specifications:

- There shall be no more than 10 call attempts to the same number within any 30 minute period for any single manual call initiation, and
- The equipment shall go on-hook for a period of not less than 30 seconds between the end of one attempt and the beginning of the next call attempt.
- The equipment shall be set to ensure that automatic calls to different numbers are spaced such that there is not less than 5 seconds between the end of one call attempt and the beginning of another.

New Zealand Telecom equipment notice

This equipment is not capable, under all operating conditions, of correct operation at the higher speeds for which it is designed. Telecom will accept no responsibility should difficulties arise in such circumstances.

South Africa telecommunications notice

This modem must be used in conjunction with an approved surge protection device when connected to the PSTN.

Using this product in Switzerland

This product requires a Swiss billing tone filter (Lexmark part number 14B5109 or 80D1877) to be installed on any line which receives metering pulses in Switzerland. The Lexmark filter must be used, as metering pulses are present on all analog telephone lines in Switzerland.

Utilisation de ce produit en Suisse

Cet appareil nécessite l'utilisation d'un filtre de tonalité de facturation suisse (n° de référence Lexmark : 14B5109 ou 80D1877) devant être installé sur toute ligne recevant des impulsions de comptage en Suisse. Ce filtre doit être utilisé pour toute installation car ces impulsions existent sur toutes les lignes téléphoniques suisses.

Verwendung dieses Produkts in der Schweiz

Für dieses Produkt muss ein schweizerischer Billing Tone Filter zur Zählzeichenübertragung (Lexmark Teilenummer 14B5109 oder 80D1877) für jede Leitung installiert werden, über die in der Schweiz Zeitsteuertakte übertragen werden. Die Verwendung des Lexmark Filters ist obligatorisch, da in allen analogen Telefonleitungen in der Schweiz Zeitsteuertakte vorhanden sind.

Uso del prodotto in Svizzera

Questo prodotto richiede un filtro toni Billing svizzero, (codice Lexmark 14B5109 o 80D1877) da installare su tutte le linee che ricevono impulsi remoti in Svizzera. È necessario utilizzare il filtro Lexmark poiché gli impulsi remoti sono presenti su tutte le linee analogiche in Svizzera.

ENERGY STAR



Laser notice

The printer is certified in the U.S. to conform to the requirements of DHHS 21 CFR Subchapter J for Class I (1) laser products, and elsewhere is certified as a Class I laser product conforming to the requirements of IEC 60825-1.

Class I laser products are not considered to be hazardous. The printer contains internally a Class IIIb (3b) laser that is nominally a 5 milliwatt gallium arsenide laser operating in the wavelength of 770-795 nanometers. The laser system and printer are designed so there is never any human access to laser radiation above a Class I level during normal operation, user maintenance, or prescribed service condition.

Laser advisory label

A laser notice label may be affixed to this printer as shown:



Power consumption

Product power consumption

The following table documents the power consumption characteristics of the product.

Note: Some modes may not apply to your product.

Mode	Description	Power consumption (Watts)
Printing	The product is generating hard-copy output from electronic inputs.	600 W
Copying	The product is generating hard-copy output from hard-copy original documents.	520 W
Scanning	The product is scanning hard-copy documents.	180 W
Ready	The product is waiting for a print job.	170 W
Power Saver	The product is in energy-saving mode.	<22 W
High Off	The product is plugged into a wall outlet, but the power switch is turned off.	N/A
Low Off (<1 W Off)	The product is plugged into a wall outlet, the power switch is turned off, and the product is in the lowest possible power consumption mode.	N/A
Off	The product is plugged into a wall outlet, but the power switch is turned off.	N/A W

The power consumption levels listed in the previous table represent time-averaged measurements. Instantaneous power draws may be substantially higher than the average.

Values are subject to change. See www.lexmark.com for current values.

Power Saver

This product is designed with an energy-saving mode called Power Saver. The Power Saver Mode is equivalent to the EPA Sleep Mode. The Power Saver Mode saves energy by lowering power consumption during extended periods of inactivity. The Power Saver Mode is automatically engaged after this product is not used for a specified period of time, called the Power Saver Timeout.

Factory default Power Saver Timeout for this product (in minutes):	30 minutes
--	------------

By using the configuration menus, the Power Saver Timeout can be modified between 1 minute and 240 minutes. Setting the Power Saver Timeout to a low value reduces energy consumption, but may increase the response time of the product. Setting the Power Saver Timeout to a high value maintains a fast response, but uses more energy.

Off mode

If this product has an off mode which still consumes a small amount of power, then to completely stop product power consumption, disconnect the power supply cord from the wall outlet.

Total energy usage

It is sometimes helpful to calculate the total product energy usage. Since power consumption claims are provided in power units of Watts, the power consumption should be multiplied by the time the product spends in each mode in order to calculate energy usage. The total product energy usage is the sum of each mode's energy usage.

Statement of Limited Warranty

Lexmark X500n

Lexmark X502n

Lexmark International, Inc., Lexington, KY

This limited warranty applies to the United States and Canada. For customers outside the U.S., refer to the country-specific warranty information that came with your product.

This limited warranty applies to this product only if it was originally purchased for your use, and not for resale, from Lexmark or a Lexmark Remarketer, referred to in this statement as "Remarketer."

Limited warranty

Lexmark warrants that this product:

- Is manufactured from new parts, or new and serviceable used parts, which perform like new parts
- Is, during normal use, free from defects in material and workmanship

If this product does not function as warranted during the warranty period, contact a Remarketer or Lexmark for repair or replacement (at Lexmark's option).

If this product is a feature or option, this statement applies only when that feature or option is used with the product for which it was intended. To obtain warranty service, you may be required to present the feature or option with the product.

If you transfer this product to another user, warranty service under the terms of this statement is available to that user for the remainder of the warranty period. You should transfer proof of original purchase and this statement to that user.

Limited warranty service

The warranty period starts on the date of original purchase as shown on the purchase receipt and ends 12 months later provided that the warranty period for any supplies and for any maintenance items included with the printer shall end earlier if it, or its original contents, are substantially used up, depleted, or consumed.

To obtain warranty service you may be required to present proof of original purchase. You may be required to deliver your product to the Remarketer or Lexmark, or ship it prepaid and suitably packaged to a Lexmark designated location. You are responsible for loss of, or damage to, a product in transit to the Remarketer or the Lexmark designated location.

When warranty service involves the exchange of a product or part, the item replaced becomes the property of the Remarketer or Lexmark. The replacement may be a new or repaired item.

The replacement item assumes the remaining warranty period of the original product.

Replacement is not available to you if the product you present for exchange is defaced, altered, in need of a repair not included in warranty service, damaged beyond repair, or if the product is not free of all legal obligations, restrictions, liens, and encumbrances.

Before you present this product for warranty service, remove all print cartridges, programs, data, and removable storage media (unless directed otherwise by Lexmark).

For further explanation of your warranty alternatives and the nearest Lexmark authorized servicer in your area contact Lexmark on the World Wide Web at <http://support.lexmark.com>.

Remote technical support is provided for this product throughout its warranty period. For products no longer covered by a Lexmark warranty, technical support may not be available or only be available for a fee.

Extent of limited warranty

Lexmark does not warrant uninterrupted or error-free operation of any product or the durability or longevity of prints produced by any product.

Warranty service does not include repair of failures caused by:

- Modification or unauthorized attachments
- Accidents, misuse, abuse or use inconsistent with Lexmark user's guides, manuals, instructions or guidance
- Unsuitable physical or operating environment
- Maintenance by anyone other than Lexmark or a Lexmark authorized servicer
- Operation of a product beyond the limit of its duty cycle
- Use of printing media outside of Lexmark specifications
- Refurbishment, repair, refilling or remanufacture by a third party of products, supplies or parts
- Products, supplies, parts, materials (such as toners and inks), software, or interfaces not furnished by Lexmark

TO THE EXTENT PERMITTED BY APPLICABLE LAW, NEITHER LEXMARK NOR ITS THIRD PARTY SUPPLIERS OR REMARKETERS MAKE ANY OTHER WARRANTY OR CONDITION OF ANY KIND, WHETHER EXPRESS OR IMPLIED, WITH RESPECT TO THIS PRODUCT, AND SPECIFICALLY DISCLAIM THE IMPLIED WARRANTIES OR CONDITIONS OF MERCHANTABILITY, FITNESS FOR A PARTICULAR PURPOSE, AND SATISFACTORY QUALITY. ANY WARRANTIES THAT MAY NOT BE DISCLAIMED UNDER APPLICABLE LAW ARE LIMITED IN DURATION TO THE WARRANTY PERIOD. NO WARRANTIES, EXPRESS OR IMPLIED, WILL APPLY AFTER THIS PERIOD. ALL INFORMATION, SPECIFICATIONS, PRICES, AND SERVICES ARE SUBJECT TO CHANGE AT ANY TIME WITHOUT NOTICE.

Limitation of liability

Your sole remedy under this limited warranty is set forth in this document. For any claim concerning performance or nonperformance of Lexmark or a Remarketer for this product under this limited warranty, you may recover actual damages up to the limit set forth in the following paragraph.

Lexmark's liability for actual damages from any cause whatsoever will be limited to the amount you paid for the product that caused the damages. This limitation of liability will not apply to claims by you for bodily injury or damage to real property or tangible personal property for which Lexmark is legally liable. **IN NO EVENT WILL LEXMARK BE LIABLE FOR ANY LOST PROFITS, LOST SAVINGS, INCIDENTAL DAMAGE, OR OTHER ECONOMIC OR CONSEQUENTIAL DAMAGES.** This is true even if you advise Lexmark or a Remarketer of the possibility of such damages. Lexmark is not liable for any claim by you based on a third party claim.

This limitation of remedies also applies to claims against any Suppliers and Remarketers of Lexmark. Lexmark's and its Suppliers' and Remarketers' limitations of remedies are not cumulative. Such Suppliers and Remarketers are intended beneficiaries of this limitation.

Additional rights

Some states do not allow limitations on how long an implied warranty lasts, or do not allow the exclusion or limitation of incidental or consequential damages, so the limitations or exclusions contained above may not apply to you.

This limited warranty gives you specific legal rights. You may also have other rights that vary from state to state.

Index

Numerics

- 530-sheet drawer
 - installing 27
- 530-sheet tray
 - loading 31

Symbols

- <xx> Service Call: <message> 94

A

- ADF Cover Open: Close ADF Cover 94
- ADF Jam: Open ADF Cover and Clear Jam 94
- Answering 94
- attaching cables 29
- Auto Clear, turning on 116
- Awaiting Redial 94

B

- broadcast fax
 - canceling 62
 - sending 62
- Busy 94
- buttons, control panel 13

C

- C Toner Empty: Replace Toner C 94
- cables, attaching
 - Ethernet 29
 - USB 29
- Calibrating 94
- calling card
 - using while listening to call 63
 - using with On Hook dial feature 63
- calling Customer Support 136
- canceling
 - broadcast fax 62
 - copy job 54
 - fax job 63
 - scan job 59
- canceling a job
 - from Mac OS 9 49
 - from Mac OSX 50
 - from the control panel 49
 - from Windows desktop 49
 - from Windows taskbar 49
- Cannot Copy: Cancel 2in1/4in1-Copy to Exec/B5 94

- Cannot Copy: Cancel Copy to Small Paper 94
- card stock
 - guidelines 43
- changing the administrator menus
 - password 114
- checking an unresponsive printer 117
- cleaning
 - dust-proof glass 101
 - exterior of the printer 99
 - scanner glass 100
- collating copies 54
- Communication Error 95
- configuration page, printing 48
- connecting
 - using RJ11 adapter 16
- connecting the printer to
 - answering machine 22
 - computer modem 24
 - telephone 21
 - telephone wall jack 19
 - telephone wall jack in Germany 20
- conserving toner 99
- contacting Customer Support 136
- control panel 13
 - locking the administrator menus 114
 - unlocking the administrator menus 114
- converting the standard tray to a legal-size tray 34
- copy quality
 - adjusting 53
- Copy Settings menu 81
- copy troubleshooting
 - copier does not respond 119
 - partial document or photo copies 120
 - poor copy quality 119
 - poor scanned image quality 121
 - scanner unit does not close 119
- copying
 - adjusting quality 53
 - canceling a copy job 54
 - collating copies 54
 - enlarging a copy 52
 - making a copy 51
 - making a copy lighter or darker 53

- multiple pages on one sheet 53
- reducing a copy 52
- selecting a paper size for copies 52
- selecting a paper tray for copies 51
- Cover Open: Close Front Cover 94
- Cover Open: Close OPC Cover 95
- Cover Open: Close Rear Cover 95

D

- demo page, printing 49
- descreening 58
- Dial Fail 95
- Dialing 95
- dialing mode
 - Pulse 67
 - Touch Tone 67
- dialing options, fax 67
- display troubleshooting
 - display is blank 117
- display, control panel 13
- documents
 - scanning text for editing 56
- documents, printing
 - from Macintosh 48
 - from Windows 48
- drawer, 530-sheet
 - removing 109
 - securing 28
- Duplicate IP: Duplicate IP Address Found 95
- dust-proof glass
 - cleaning 101

E

- editing
 - document text (OCR) 56
- Email Size Over: Email Size Limit Exceeded 95
- Embedded Web Server 116
- emission notices 138, 139, 140
- enlarging a copy 52
- envelopes
 - guidelines 41
- Ethernet port 29
- exit bin
 - setting up 37
- exterior of the printer
 - cleaning 99

F

- Fail to Connect to Server: Server Connection Failed 95
- FAQ about color printing 135
- fax
 - receive modes 64
 - resolution 69
- Fax Directory menu 86
- Fax Settings menu 84
- fax troubleshooting
 - can receive but not send faxes 125
 - can send but not receive faxes 124
 - cannot send or receive a fax 122
 - received fax has poor print quality 125
- faxing
 - adjusting fax activity report settings 65
 - canceling a broadcast fax 62
 - canceling a fax job 63
 - changing the fax resolution 69
 - choosing a fax connection 16
 - dialing options 67
 - editing Quick Dial numbers 65
 - editing Speed Dial numbers 66
 - making a fax lighter or darker 69
 - printing fax activity reports 65
 - printing the Quick Dial list 66
 - printing the Speed Dial list 66
 - receiving a fax at the end of a conversation 64
 - receiving a fax from an extension telephone 65
 - reducing the print size of an incoming fax 70
 - selecting a paper tray for incoming faxes 70
 - sending a broadcast fax 62
 - sending a fax at the end of a conversation 63
 - sending a fax while behind a PBX 68
 - setting number of rings before answering 68
 - setting the date 25
 - setting the dialing mode 67
 - setting the fax receive mode 64
 - setting the outgoing fax name and number 25
 - setting the time 26
 - setting up Quick Dial numbers 65

- setting up real time fax transmission 70
- setting up Speed Dial numbers 66
- setting volume 67
- understanding fax receive modes 64
- using the ADF 61
- using the scanner glass 62
- while listening to call 63

FCC notices 138, 140

fuser

- ordering 107

Fuser Life: Replace Fuser 95

G

guidelines

- card stock 43
- envelopes 41
- labels 42
- letterhead 40
- transparencies 41

I

Incoming Call 95

Initializing 95

installing printer software 48

J

jams

- accessing 71
- avoiding 71
- behind rear door 76
- involving Tray 1 73
- involving Tray 2 75

jams and misfeeds troubleshooting

- paper jam in ADF 77

Job # 95

K

K Toner Empty: Replace Toner K 94

L

labels

- guidelines 42

legal-size tray

- loading 34

letterhead

- guidelines 40

light, indicator 13

linking trays 38

loading

- 530-sheet tray 31
- legal tray 34

standard tray 31

locking

- administrator menus 114
- scanner 108

M

M Toner Empty: Replace Toner M 94

Machine Settings menu 87

Memory Full 95

Memory Near Full 95

menus

- Copy Settings 81
- diagram of 81
- Fax Directory 86
- Fax Settings 84
- Machine Settings 87
- Network Settings 90
- Reports Print 90
- Scan Settings 83
- Settings 91

Missing: Install Fuser Unit 96

Missing: Install OPC Belt 96

Missing: Install Toner <x> 96

Missing: Install Transfer Roller 96

moving the printer 107, 112

multiple pages on one sheet 53

N

network information, printing 48

Network Settings menu 90

No Memory: Out of Memory 96

No Response 96

noise emission levels 140

notices 137, 138, 139, 140, 141, 142, 143, 144

O

OCR, editing document text 56

On Hook Dial

- using 63

online customer support 117

OPC Belt Life: Replace OPC Belt 96

OPC Exhausted: Replace OPC Belt 96

options

- 530-sheet drawer 27

ordering

- fuser 107
- photodeveloper cartridge 107
- toner cartridges 106
- waste toner bottle 107

P

- paper
 - capacities 46
 - characteristics 39
 - letterhead 40
 - preprinted forms 40
 - selecting 40
 - setting type 37
 - storing 43
 - unacceptable 40
- Paper Change: Load Tray<x>
<paper type> 96
- Paper Empty: Load Tray 1 <paper type> 96
- Paper Empty: Load Tray 2 <paper type> 96
- Paper Error: Load Tray 1 <paper type> 96
- paper feed troubleshooting
 - message remains after jam is cleared 127
- Paper Jam A1 96
- Paper Jam A2 96
- Paper Jam B 96
- Paper Jam C 96
- paper jams
 - avoiding 71
 - behind rear door 76
 - involving Tray 1 73
 - involving Tray 2 75
- paper sizes, supported 44
- paper types
 - where to load 45
- paper weights, supported 46
- password
 - administrator menus 114
- PC Printing 96
- PF1 Kit Life: Replace PF Kit 1 96
- PF2 Kit Life: Replace PF Kit 2 96
- photodeveloper cartridge
 - ordering 107
- Place Next Page: Then Press Set 97
- Please Wait 97
- Power Saver
 - adjusting 114
- print job
 - canceling from Mac OS 9 49
 - canceling from Mac OSX 50
 - canceling from Windows desktop 49
 - canceling from Windows taskbar 49
- print quality
 - cleaning the dust-proof glass 101
 - cleaning the scanner glass 100
- print quality troubleshooting
 - blank pages 133
 - clipped images 133
 - color misregistration 128
 - ghost images 132
 - gray background 131
 - light colored line, white line, or incorrectly colored line 128
 - poor transparency quality 131
 - print irregularities 130
 - print is too dark 131
 - print is too light 130
 - repeating defects 127
 - skewed print 132
 - smearred vertical print 128
 - solid color pages 134
 - streaked horizontal lines 129
 - streaked vertical lines 129
 - toner rubs off 135
 - toner specks 134
 - uneven print density 132
- print troubleshooting
 - incorrect margins 132
 - job takes longer than expected 118
 - jobs do not print 117
 - multiple-language PDFs do not print 117
 - paper curl 134
 - paper frequently jams 127
 - tray linking does not work 118
 - unexpected page breaks occur 118
- printer
 - configurations 10
 - models 10
 - moving 107, 112
 - setting up in new location 112
- printer messages
 - <xx> Service Call:
<message> 94
 - ADF Cover Open: Close ADF Cover 94
 - ADF Jam: Open ADF Cover and Clear Jam 94
 - Answering 94
 - Awaiting Redial 94
 - Busy 94
 - C Toner Empty: Replace Toner C 94
 - Calibrating 94
 - Cannot Copy: Cancel 2in1/4in1-Copy to Exec/B5 94
 - Cannot Copy: Cancel Copy to Small Paper 94
 - Communication Error 95
 - Cover Open: Close Front Cover 94
 - Cover Open: Close OPC Cover 95
 - Cover Open: Close Rear Cover 95
 - Dial Fail 95
 - Dialing 95
 - Duplicate IP: Duplicate IP Address Found 95
 - Email Size Over: Email Size Limit Exceeded 95
 - Fail to Connect to Server: Server Connection Failed 95
 - Fuser Life: Replace Fuser 95
 - Incoming Call 95
 - Initializing 95
 - Job # 95
 - K Toner Empty: Replace Toner K 94
 - M Toner Empty: Replace Toner M 94
 - Memory Full 95
 - Memory Near Full 95
 - Missing: Install Fuser Unit 96
 - Missing: Install OPC Belt 96
 - Missing: Install Toner <x> 96
 - Missing: Install Transfer Roller 96
 - No Memory: Out of Memory 96
 - No Response 96
 - OPC Belt Life: Replace OPC Belt 96
 - OPC Exhausted: Replace OPC Belt 96
 - Paper Change: Load Tray<x> <paper type> 96
 - Paper Empty: Load Tray 1 <paper type> 96
 - Paper Empty: Load Tray 2 <paper type> 96
 - Paper Error: Load Tray 1 <paper type> 96
 - Paper Jam A1 96
 - Paper Jam A2 96
 - Paper Jam B 96
 - Paper Jam C 96
 - PC Printing 96
 - PF1 Kit Life: Replace PF Kit 1 96
 - PF2 Kit Life: Replace PF Kit 2 96

- Place Next Page: Then Press Set 97
- Please Wait 97
- Printing 97
- Ready 97
- Receiving 97
- RX Comm Error 97
- Scan Calibration Error 97
- Scan Lock Error: Unlock Scanner 97
- Scan Memory Near Full 97
- Scan Network Disconnect 97
- Scan USB Disconnect 97
- Scanning Page 97
- Send Email Notify: Send Email Notification 97
- Sending File 97
- Set Correct Paper 98
- Sleep 98
- TAD Answering 98
- Toner error: Install supported toner cartridge 98
- Toner Low <xxxx> 98
- TR Belt Life: Replace Transfer Belt 98
- TR Kit Life: Replace PQ Kit 98
- Transmitting 98
- Tray 1 Missing: Insert Tray 98
- Tray 1_2 Missing: Insert Tray 98
- Tray 2 Missing: Insert Tray 98
- TX Comm Error 98
- Warming up 98
- Waste pack full 98
- Y Toner Empty: Replace Toner Y 94
- printer options troubleshooting
 - drawers 126
 - option not working 126
- Printing 97
- printing
 - configuration page 48
 - demo page 49
 - from Macintosh 48
 - from Windows 48
 - installing printer software 48
 - network information 48
 - supply information 48
- Pulse dialing mode 67

Q

- Quick Dial
 - editing Quick Dial numbers 65
 - setting up Quick Dial numbers 65

R

- Ready 97
- real time fax transmission 70
- Receiving 97
- receiving a fax
 - at the end of a conversation 64
 - from an extension telephone 65
 - setting the fax receive mode 64
- recycling
 - WEEE statement 140
- reducing a copy 52
- reports
 - fax activity 65
 - Quick Dial list 66
 - Speed Dial list 66
- Reports Print menu 90
- reports, fax activity
 - adjusting settings 65
- restoring factory default settings 115
- RJ11 adapter, using 16
- RX Comm Error 97

S

- safety information 9
- Scan Calibration Error 97
- Scan Lock Error: Unlock Scanner 97
- Scan Memory Near Full 97
- Scan Network Disconnect 97
- scan resolution
 - adjusting 59
- Scan Settings menu 83
- scan troubleshooting
 - cannot scan from a computer 122
 - partial document or photo scans 122
 - scan was not successful 121
 - scanner does not respond 121
 - scanner unit does not close 119
 - scanning takes too long or freezes the computer 121
- Scan USB Disconnect 97
- scanner
 - locking 108
- scanner glass
 - cleaning 100
- scanning
 - adjusting resolution 59
 - canceling a scan 59
 - changing the Document Size setting 59
 - customizing settings using the computer 56

- directly from an application 56
- editing text 56
- from magazines and newspapers 58
- making a scanned image lighter or darker 60
- scanning to a computer 59
- scanning to a computer over a network 58
- scanning to an e-mail address 59
- scanning to an FTP address 59
- searching the scan directory 59
- setting up the scan directory 59
- using the computer 55
- using the control panel 58

Scanning Page 97

Send Email Notify: Send Email Notification 97

Sending File 97

Set Correct Paper 98

setting

- Default mode 115
- paper type 37

Settings menu 91

Sleep 98

Speed Dial

- editing Speed Dial numbers 66
- setting up Speed Dial numbers 66

standard exit bin

- setting up 37

standard tray

- converting to a legal-size tray 34
- loading 31

storing

- paper 43
- supplies 99

supplies

- conserving toner 99
- storing 99

supplies, ordering

- fuser 107
- photodeveloper cartridge 107
- toner cartridges 106
- waste toner bottle 107

supply information, printing 48

T

- TAD Answering 98
- telecommunication notices 140, 141, 142
- toner
 - conserving 99

- toner cartridges
 - ordering 106
- Toner error: Install supported toner cartridge 98
- Toner Low <xxxx> 98
- Touch Tone dialing mode 67
- TR Belt Life: Replace Transfer Belt 98
- TR Kit Life: Replace PQ Kit 98
- Transmitting 98
- transparencies
 - guidelines 41
- Tray 1 Missing: Insert Tray 98
- Tray 1_2 Missing: Insert Tray 98
- Tray 2 Missing: Insert Tray 98
- tray linking 38
- troubleshooting
 - checking an unresponsive printer 117
 - contacting Customer Support 136
 - FAQ about color printing 135
 - online customer support 117
- troubleshooting, copy
 - copier does not respond 119
 - partial document or photo copies 120
 - poor copy quality 119
 - poor scanned image quality 121
 - scanner unit does not close 119
- troubleshooting, display
 - display is blank 117
- troubleshooting, fax
 - can receive but not send faxes 125
 - can send but not receive faxes 124
 - cannot send or receive a fax 122
 - received fax has poor print quality 125
- troubleshooting, jams and misfeeds
 - paper jam in ADF 77
- troubleshooting, paper feed
 - message remains after jam is cleared 127
- troubleshooting, print
 - incorrect margins 132
 - job takes longer than expected 118
 - jobs do not print 117
 - multiple-language PDFs do not print 117
 - paper curl 134
 - paper frequently jams 127

- tray linking does not work 118
- unexpected page breaks occur 118
- troubleshooting, print quality
 - blank pages 133
 - clipped images 133
 - color misregistration 128
 - ghost images 132
 - gray background 131
 - light colored line, white line, or incorrectly colored line 128
 - poor transparency quality 131
 - print irregularities 130
 - print is too dark 131
 - print is too light 130
 - repeating defects 127
 - skewed print 132
 - smearred vertical print 128
 - solid color pages 134
 - streaked horizontal lines 129
 - streaked vertical lines 129
 - toner rubs off 135
 - toner specks 134
 - uneven print density 132
- troubleshooting, printer options
 - drawers 126
 - option not working 126
- troubleshooting, scan
 - cannot scan from a computer 122
 - partial document or photo scans 122
 - scan was not successful 121
 - scanner does not respond 121
 - scanner unit does not close 119
 - scanning takes too long or freezes the computer 121
- turning on Auto Clear 116
- TX Comm Error 98

U

- unlocking
 - administrator menus 114
- USB port 29
- using RJ11 adapter 16

V

- volume settings 67

W

- Warming up 98
- Waste pack full 98
- waste toner bottle
 - ordering 107

Y

- Y Toner Empty: Replace Toner
- Y 94